

SECTION IV

KNEE JOINTS

1000 SERIES

2000 SERIES

9000 SERIES

**KNEE JOINT ACCESSORIES
AND COST SAVING KITS**

BECKER KNEE JOINT SYSTEM

The following pages illustrate the entire line of Becker knee joint systems. Each is available in a variety of joint sizes, upright materials and upright thicknesses. This represents the largest selection of knee joints on the market today, enabling the orthotist to select a knee joint that perfectly matches the design, strength, and weight considerations of the completed orthosis.

Many of our knee joints are available in four sizes: A (Adult), B (Youth), C (Child) and I (Infant). In our system, as the sizes get smaller, the dimensions of the stainless steel midsections are proportionally reduced. Please see the size specifications on the pages that follow.

All of our knee joints are sent fully assembled to reduce your fabrication time. Our uprights are riveted into the knee joint midsections; we have found this procedure to be significantly stronger and more reliable than attachment screws.

Many of our knee joints are now available with pre-contoured lower joint units for improved cosmesis. The pages that follow are devoted to our material and size specifications, which will serve as a useful reference for anyone using our knee joint systems.

CAUTION: IMPORTANT INFORMATION

- To maintain the structural integrity of the upright material, it is essential for the orthotist to know the contouring limits. The contour radius for 2024 T-4 aluminum is approximately six times the material thickness. For example, if the thickness is 3/16" the maximum contour radius would be $6 \times 3/16"$ or 1-1/8". Therefore, a circle with a 1-1/8" radius would show the most extreme contour you can use without risking micro-fractures. The bend radius for 304-2B stainless 1/4 temper is one times thickness.
- When assembling the levers of our models 1003, 1004, 1007, 1011, and LR-9002 please follow the lever fitting instructions in our Technical Catalog.
- All of our ring lock or lever lock joints are equipped with locks on both the medial and lateral sides. We will not be responsible if one of the locks is removed. Medial and lateral locks distribute the load forces, resulting in a safer and longer lasting orthosis.

BECKER KNEE JOINT SYSTEM

Below you will find all size specifications for Becker knee joints. Please refer to the chart below or call one of our customer service representatives with any questions you may have. This page is provided as a tool for orthotists to use in choosing the most appropriate knee joint for their patient's orthosis.

MATERIAL SPECIFICATIONS

Product	Material
1000 Series Knee Joint Midsections	410 Hardened Stainless Steel
2000 Series Knee Joint Midsections	304-2B Stainless Steel 1/4 Temper
9001 Midsection	410 Hardened Stainless Steel
9002 Midsection	410 Hardened Stainless Steel
9003 Joint Body	Carbon Fiber
9004 Knee Joint Midsections	440 Stainless Steel
Aluminum Uprights	2024 T4 Aluminum
Stainless Steel Uprights	304-2B Stainless Steel 1/4 Temper
Titanium Uprights	6-4 Titanium

UPRIGHT CONVERSIONS

Inches	Millimeters
1/8"	3mm
5/32"	4mm
3/16"	5mm
1/4"	6mm
5/16"	8mm
9/32"	6.75mm
3/8"	9.5mm
1/2"	13mm
5/8"	16mm
3/4"	19mm
7/8"	22mm
1"	25mm
1-1/4"	32mm

1000 SERIES				
	A SIZE	B SIZE	C SIZE	I SIZE
Designed For	**Adults 120#	**Youths 50-120#	**Children 30-50#	**Infants Under 30#
Model 1014	**Adults < 160#	**Youths < 120#	**Children < 60#	~
Bar Width	3/4"	5/8"	1/2"	1/2"
Bar Thickness	1/4", 3/16", 5/32"	1/4", 3/16", 5/32"	3/16", 1/8"	1/8"
Bushing Hole Diameter	3/8"	3/8"	5/16"	5/16"
Upright Attachment Holes	#12 Drill	#22 Drill	#30 Drill	#30 Drill
Upright Attachment Rivet	RVT-A	RVT-BL/RVT-BS	RVT-C	RVT-C

Model No.	Midsection Length				Proximal Upright Length (from KC)				Distal Upright Length (from KC)			
	A Size	B Size	C Size	I Size	A Size	B Size	C Size	I Size	A Size	B Size	C Size	I Size
1001	3-3/8"	3-1/8"	2-3/8"	~	15-7/8"	14-3/4"	12-5/8"	~	21-5/8"	18-5/8"	16-1/2"	~
1002*	3-1/2"	2-7/8"	2-1/2"	1-5/8"	15-5/8"	14-5/8"	12-1/2"	12-1/2"	21-7/8"	18-3/4"	16-5/8"	14-1/2"
1003*	3-5/8"	3-1/8"	~	~	16"	14-7/8"	~	~	21-5/8"	18-5/8"	~	~
1004*	3-5/8"	3-1/8"	~	~	15-7/8"	14-7/8"	~	~	21-5/8"	18-5/8"	~	~
1005	3-1/4"	2-3/4"	2-1/4"	~	15-5/8"	14-5/8"	12-3/8"	~	21-5/8"	18-5/8"	16-1/2"	~
1006	3-5/8"	3-1/2"	3-3/8"	~	15-7/8"	14-3/4"	12-5/8"	~	19-1/2"	19-1/2"	17-3/8"	~
1007	3-7/8"	3-1/2"	~	~	16"	14-7/8"	~	~	19-1/2"	19-1/2"	~	~
1008*	3-1/8"	3"	2-3/8"	1-1/2"	15-1/2"	14-1/2"	12-3/8"	12-3/8"	21-1/2"	18-3/8"	16-1/2"	16-3/8"
1009	4-1/4"	3-3/4"	2-7/8"	~	15-5/8"	14-5/8"	12-1/2"	~	22-5/8"	19-1/2"	17-1/8"	~
1010	3-5/8"	3-1/2"	3-3/8"	~	15-7/8"	14-3/4"	12-5/8"	~	19-1/2"	19-1/2"	17-3/8"	~
1011	3-5/8"	3-1/8"	~	~	16"	14-7/8"	~	~	21-5/8"	18-5/8"	~	~
1012*	3-1/8"	3"	2-3/8"	1-1/2"	15-1/2"	14-1/2"	12-3/8"	12-3/8"	21-1/2"	18-3/8"	16-1/2"	16-3/8"
1014/1015	3-5/8"	3-1/4"	2-5/8"	~	15-5/8"	14-1/2"	12-3/8"	~	22"	18-3/4"	16-5/8"	~
1016*	~	3-1/4"	~	~	~	14-3/4"	~	~	~	18-7/8"	~	~
1500	1"	~	~	~	7-7/16"	~	~	~	7-7/16"	~	~	~
1600	1"	~	~	~	7-7/16"	~	~	~	6-5/8"	~	~	~
1700	~	2-1/2"	2-1/2"	~	~	14-1/2"	12-1/2"	~	~	18-1/2"	16-1/2"	~
1800	~	4-1/2"	~	~	~	16-3/8"	~	~	~	16-3/8"	~	~
1900	4-7/8"	1-1/8"	7/8"	~	15-1/2"	5"	3"	~	19-3/8"	5"	3"	~

NOTE: Material and size specifications are subject to change without notice.

*Available with contoured lower joint units which effectively reduce the overall midsection length

**Discretion in choosing a joint size and designing an appropriate orthosis should be used by the orthotist in all cases

BECKER KNEE JOINT SYSTEM CONTINUED

2000 SERIES			
	A SIZE	B SIZE	C SIZE
Designed For:	**Adults 120#	**Youths 50-120#	**Children 30-50#
Bar Width	3/4"	5/8"	1/2"
Bar Thickness	1/4", 3/16"	1/4", 3/16"	3/16", 1/8"
Bushing Hole Diameter	3/8"	3/8"	5/16"
Upright Attachment Holes	#12 Drill	#22 Drill	#30 Drill
Upright Attachment Rivet	RVT-A	RVT-BL/RVT-BS	RVT-C

Model No.	Midsection Length			Proximal Upright Length (from KC)			Distal Upright Length (from KC)		
	A Size	B Size	C Size	A Size	B Size	C Size	A Size	B Size	C Size
2000	~	2-1/2"	2-1/2"	~	14-1/2"	12-1/2"	~	8-1/2"	7-1/2"
S2001	2-3/8"	2"	1-3/4"	15-3/8"	14-3/8"	12-1/4"	19-1/2"	19-1/2"	14-1/2"
S2005	2-3/8"	2"	1-3/4"	15-1/2"	14-1/2"	12-3/8"	19-1/2"	19-1/2"	14-1/2"
R2001	2-3/8"	2"	1-3/4"	15-1/2"	14-3/8"	12-3/8"	19-1/2"	19-1/2"	14-1/2"
R2005	2-3/8"	2"	1-3/4"	15-1/2"	14-1/2"	12-3/8"	19-1/2"	19-1/2"	14-1/2"
S2003	4-1/2"	~	2-3/4"	15-1/2"	~	12-3/8"	21-5/8"	~	14-1/8"
2004	~	2-3/8"	~	~	4-7/8"	~	~	5"	~

**Discretion in choosing a joint size and designing an appropriate orthosis should be used by the orthotist in all cases.

MODEL 9002	
	A SIZE
Designed For:	**Adults 120#
Bar Width	3/4"
Bar Thickness	3/16", 1
Bushing Hole Diameter	3/8"
Upright Attachment Holes	#12 Drill
Upright Attachment Rivet	RVT-A

**Discretion in choosing a joint size and designing an appropriate orthosis should be used by the orthotist in all cases

Model No.	Midsection Length	Proximal Upright Length (from KC)	Distal Upright Length (from KC)
	A Size	A Size	A Size
9001	5-3/8"	16-1/2"	22-3/4"
9002	3-7/8"	15-7/8"	22-1/8"
9003*	9"	8-1/8"	21-1/4"
9004**	4-1/4"	10-7/8"	15-5/8"

*Entire proximal bar cannot be contoured

**Proximal and distal bars are limited in contouring ability

NOTE: Material and size specifications are subject to change without notice.

SECTION IV

KNEE JOINTS

1000 SERIES

2000 SERIES

9000 SERIES

**KNEE JOINT ACCESSORIES
AND COST SAVING KITS**

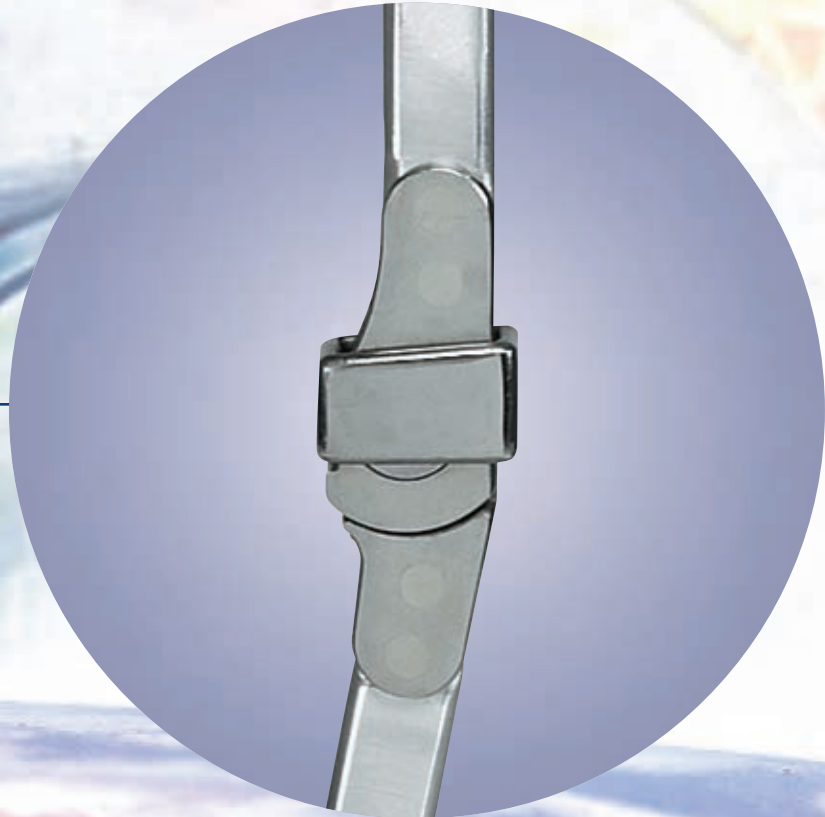

BECKER KNEE JOINT SYSTEM

HOW TO ORDER

First, choose the model number of the knee joint you wish to purchase. Second, decide if you want round edge aluminum uprights, square edge aluminum uprights or round edge stainless steel uprights (a separate box of order numbers will be underneath each type of upright). Third, choose the joint size: "A" (Adult), "B" (Youth), "C" (Child) or "I" (Infant). Last, choose the upright dimension and use the order number to the left of that size.

EXPLANATION OF NUMBERING SYSTEM

It is not necessary to understand our numbering system to order our products. Nevertheless, we take this opportunity to explain the system so the orthotist can understand the rationale behind it.

STEP 1: The first four numbers refer to the model number of the knee joint, e.g. 1002.

STEP 2: The number is followed by a letter designating joint size, e.g. 1002-A.

STEP 3: The letter will be followed by a code number indicating upright thickness (see table 1 below), e.g., 1002-A4.

STEP 4: This will be followed by a code letter designating upright material type (see table 2 below), e.g. 1002-A4T.

STEP 5: If the joint is available with contoured lower joint units, a final code letter will be added to indicate the combination you desire, e.g. 1002-A4TR (see table 3 below).

NOTE: The example for this order number is listed on page 4.1.5.

TABLE 1

Code No.	Upright Thickness
4	1/4"
6	3/16"
2	5/32"
8	1/8"

TABLE 2

Code Letter	Upright Material
None	Round Edge Aluminum
T	Square Edge Aluminum
S	Stainless Steel
TI	Titanium

TABLE 3

Code Letter	Description
None	No Contour
R	Right Medial Contoured and Right Lateral Straight or Left Lateral Contoured and Left Medial Straight
L	Left Medial Contoured and Left Lateral Straight or Right Lateral Contoured and Right Medial Straight
B	Both Medial and Lateral Contoured

Ordering Example

1002-A6SB

Model: Four digit number refers to the model number of the desired knee joint

Joint Size: A = Adult

Upright Thickness: 6 = 3/16"

Upright Material: S = Stainless steel

Countour Option: B = Both Medial and Lateral Contoured

SAMPLE: 1002-A6SB

1002 Model, Adult Size, 3/16" Upright Thickness, Stainless Steel, Both Medial and Lateral Contoured

MODEL 1001 RING LOCK KNEE JOINT

The extended locking surface of this knee joint makes it the strongest ring lock we manufacture.

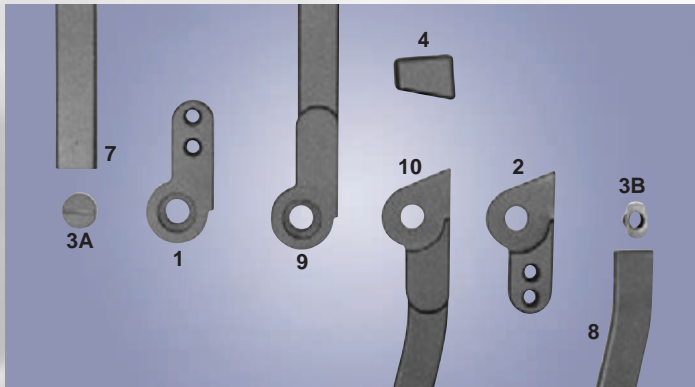

To order parts, please specify the order number, right or left, medial or lateral, followed by the part number desired.

MODEL 1001 WITH ROUND EDGE ALUMINUM UPRIGHTS

Order No.	Joint Size	Upright Dimensions
1001-A4	A	1/4" x 3/4"
1001-A6	A	3/16" x 3/4"
1001-B4	B	1/4" x 5/8"
1001-B6	B	3/16" x 5/8"
1001-C6	C	3/16" x 1/2"
1001-C8	C	1/8" x 1/2"

MODEL 1001 WITH SQUARE EDGE ALUMINUM UPRIGHTS

Order No.	Joint Size	Upright Dimensions
1001-A4T	A	1/4" x 3/4"
1001-A6T	A	3/16" x 3/4"
1001-B4T	B	1/4" x 5/8"
1001-B6T	B	3/16" x 5/8"
1001-C6T	C	3/16" x 1/2"
1001-C8T	C	1/8" x 1/2"

MODEL 1001 WITH ROUND EDGE STAINLESS STEEL UPRIGHTS

Order No.	Joint Size	Upright Dimensions
1001-A2S	A	5/32" x 3/4"
1001-A6S	A	3/16" x 3/4"
1001-B2S	B	5/32" x 5/8"
1001-B6S	B	3/16" x 5/8"
1001-C6S	C	3/16" x 1/2"
1001-C8S	C	1/8" x 1/2"

MODEL 1001 WITH ROUND EDGE TITANIUM UPRIGHTS

Order No.	Joint Size	Upright Dimensions
1001-A6TI	A	3/16" x 3/4"



- Shipped fully assembled
- Durable lock design
- **Do not remove medial or lateral ring**

MODEL 1002 MODIFIED RING LOCK KNEE JOINT

Becker Orthopedic introduced the Modified Ring Lock knee joint in 1964 to eliminate the sharp protrusion of standard ring locks in the flexed position. The joints illustrated on this page are fully compatible with the contoured joints shown on the following page.

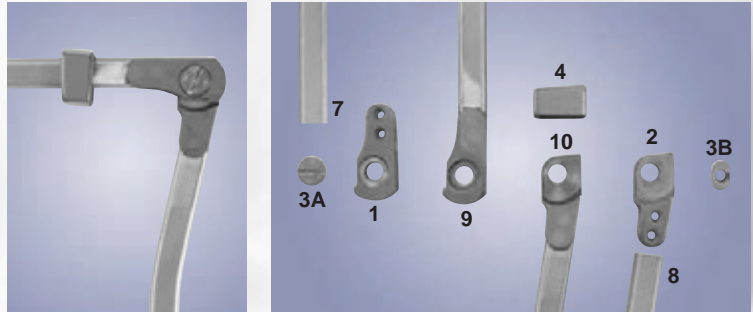
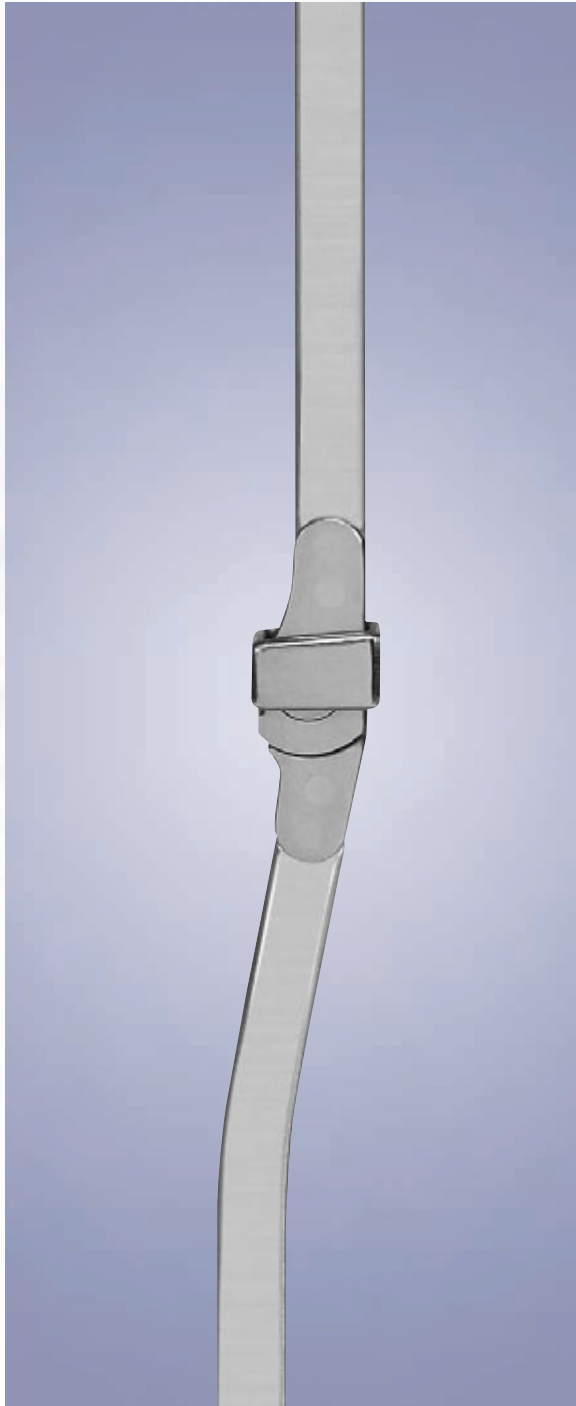

NO PROTRUSIONS To order parts, please specify the order number, right or left, medial or lateral, followed by the part number desired.

MODEL 1002 WITH ROUND EDGE ALUMINUM UPRIGHTS

Order No.	Joint Size	Upright Dimensions
1002-A4	A	1/4" x 3/4"
1002-A6	A	3/16" x 3/4"
1002-B4	B	1/4" x 5/8"
1002-B6	B	3/16" x 5/8"
1002-C6	C	3/16" x 1/2"
1002-C8	C	1/8" x 1/2"

MODEL 1002 WITH SQUARE EDGE ALUMINUM UPRIGHTS

Order No.	Joint Size	Upright Dimensions
1002-A4T	A	1/4" x 3/4"
1002-A6T	A	3/16" x 3/4"
1002-B4T	B	1/4" x 5/8"
1002-B6T	B	3/16" x 5/8"
1002-C6T	C	3/16" x 1/2"
1002-C8T	C	1/8" x 1/2"

MODEL 1002 WITH ROUND EDGE STAINLESS STEEL UPRIGHTS

Order No.	Joint Size	Upright Dimensions
1002-A6S	A	3/16" x 3/4"
1002-B2S	A	5/32" x 5/8"
1002-B6S	B	3/16" x 5/8"
1002-C6S	B	3/16" x 1/2"
1002-C8S	C	1/8" x 1/2"

MODEL 1002 WITH ROUND EDGE TITANIUM UPRIGHTS

Order No.	Joint Size	Upright Dimensions
1002-A6TI	A	3/16" x 3/4"

- Shipped fully assembled
- No protrusion when flexed
- **Do not remove medial or lateral ring**

MODEL 1002 WITH CONTOURED LOWER JOINT UNITS

The Modified Ring Lock knee joint may be purchased with pre-contoured lower joint units for improved cosmesis. Contoured joints are fully compatible with the straight joints illustrated on the preceding page. The following anterior view photos illustrate the combinations possible.

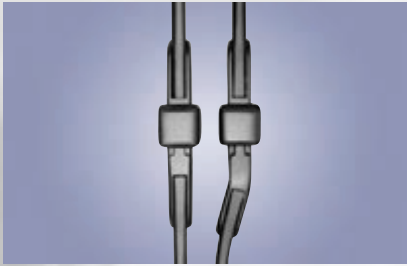

Right Medial Contoured.
Right Lateral Straight.
Code Letter "R".

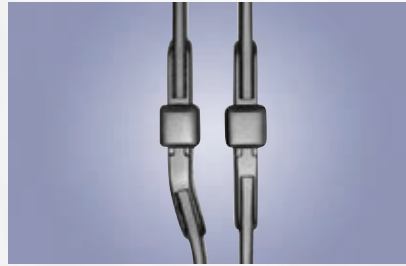

Left Medial Contoured.
Left Lateral Straight.
Code Letter "L".

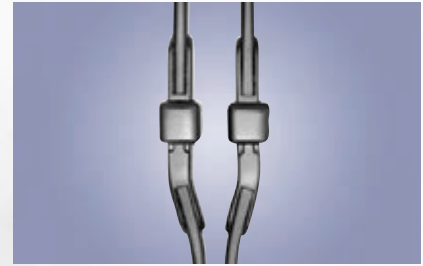

Both Medial and Lateral Contoured.
Code Letter "B".

CONTOURED MODEL 1002 WITH ROUND EDGE ALUMINUM UPRIGHTS

Order No.	Joint Size	Upright Dimensions	Contoured Side
1002-A4R	A	1/4" x 3/4"	Right Medial
1002-A4L	A	1/4" x 3/4"	Left Medial
1002-A4B	A	1/4" x 3/4"	Both
1002-A6R	A	3/16" x 3/4"	Right Medial
1002-A6L	A	3/16" x 3/4"	Left Medial
1002-A6B	A	3/16" x 3/4"	Both
1002-B4R	B	1/4" x 5/8"	Right Medial
1002-B4L	B	1/4" x 5/8"	Left Medial
1002-B4B	B	1/4" x 5/8"	Both
1002-B6R	B	3/16" x 5/8"	Right Medial
1002-B6L	B	3/16" x 5/8"	Left Medial
1002-B6B	B	3/16" x 5/8"	Both

CONTOURED MODEL 1002 WITH SQUARE EDGE ALUMINUM UPRIGHTS

Order No.	Joint Size	Upright Dimensions	Contoured Side
1002-A4TR	A	1/4" x 3/4"	Right Medial
1002-A4TL	A	1/4" x 3/4"	Left Medial
1002-A4TB	A	1/4" x 3/4"	Both
1002-A6TR	A	3/16" x 3/4"	Right Medial
1002-A6TL	A	3/16" x 3/4"	Left Medial
1002-A6TB	A	3/16" x 3/4"	Both
1002-B4TR	B	1/4" x 5/8"	Right Medial
1002-B4TL	B	1/4" x 5/8"	Left Medial
1002-B4TB	B	1/4" x 5/8"	Both
1002-B6TR	B	3/16" x 5/8"	Right Medial
1002-B6TL	B	3/16" x 5/8"	Left Medial
1002-B6TB	B	3/16" x 5/8"	Both

CONTOURED MODEL 1002 WITH ROUND EDGE STAINLESS STEEL UPRIGHTS

Order No.	Joint Size	Upright Dimensions	Contoured Side
1002-A6SR	A	3/16" x 3/4"	Right Medial
1002-A6SL	A	3/16" x 3/4"	Left Medial
1002-A6SB	A	3/16" x 3/4"	Both
1002-B6SR	B	3/16" x 5/8"	Right Medial
1002-B6SL	B	3/16" x 5/8"	Left Medial
1002-B6SB	B	3/16" x 5/8"	Both

CONTOURED MODEL 1002 WITH ROUND EDGE TITANIUM UPRIGHTS

Order No.	Joint Size	Upright Dimensions	Contoured Side
1002-A6TIR	A	3/16" x 3/4"	Right Medial
1002-A6TIL	A	3/16" x 3/4"	Left Medial
1002-A6TIB	A	3/16" x 3/4"	Both

MODELS 1002-I AND 1002-II MODIFIED INFANT RING LOCK KNEE JOINT

These models are specially designed for children less than one year old. All uprights are 1/8" x 1/2".

Order No.	Distal Upright	Midsection Length
1002-I8	Aluminum	1-5/8"
1002-I8S	Stainless Steel	1-5/8"
1002-I8T	Square Edge Aluminum	1-5/8"
1002-II	Aluminum	1-1/4"
1002-IIS	Stainless Steel	1-1/4"



- There is no lower joint unit on either infant size models
- Model 1002-II shown

NOTE: Models 1002-II and 1002-IIS are not available with ball catches.

MODEL 1003 AUTOMATIC SPRING LEVER KNEE JOINT

Model 1003 has a spring loaded lever system which automatically engages the lock when the joint reaches full extension. The joints illustrated on this page are fully compatible with the contoured joints shown on the following page. **NOTE: Please follow lever fitting instructions in our Technical Catalog.**

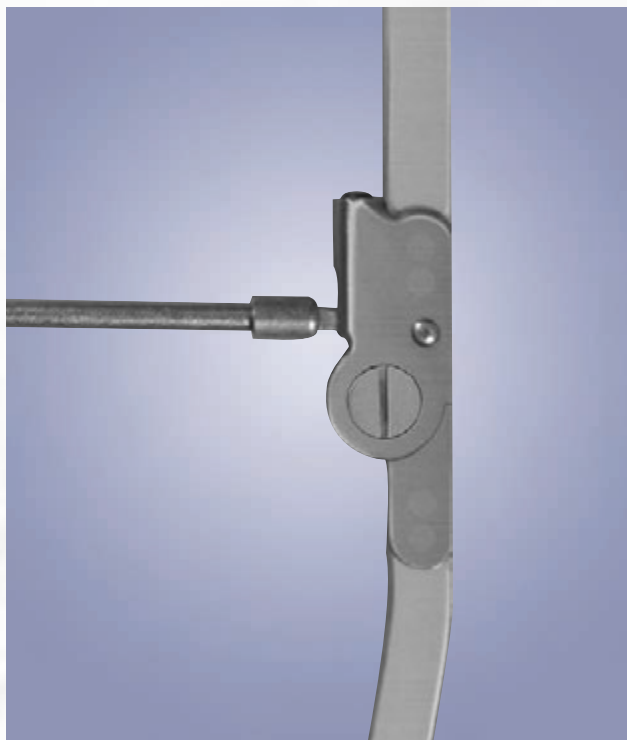

- Shipped fully assembled
- Locking mechanism automatically engages at full extension
- Heavy Duty Lever Release System may be added
- **Do not remove medial or lateral lock**

MODEL MX-003-HD HEAVY DUTY LEVER RELEASE SYSTEM

- Replaces standard bail rod
- Simultaneously unlocks both joints with a single trigger

NOTE: For ordering information please see page 4.4.3.

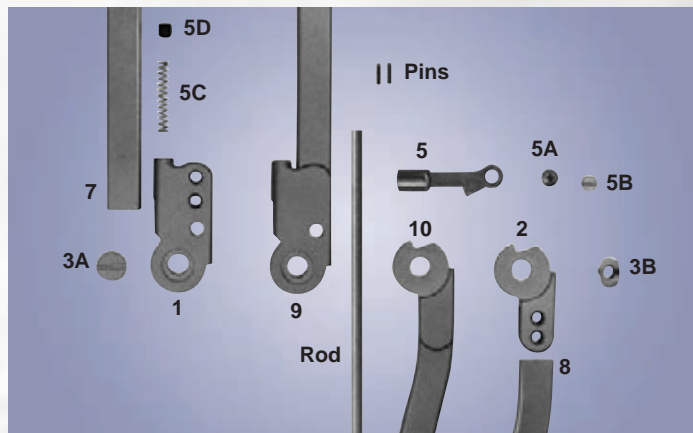
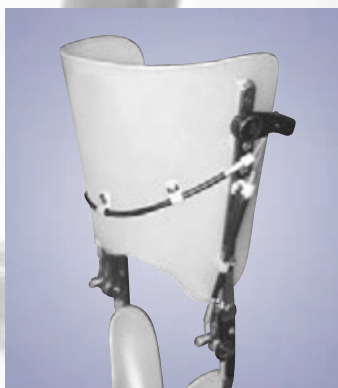

To order parts, please specify the order number, right or left, medial or lateral, followed by the part number desired.

MODEL 1003 WITH ROUND EDGE ALUMINUM UPRIGHTS

Order No.	Joint Size	Upright Dimensions
1003-A4	A	1/4" x 3/4"
1003-A6	A	3/16" x 3/4"
1003-B4	B	1/4" x 5/8"
1003-B6	B	3/16" x 5/8"

MODEL 1003 WITH SQUARE EDGE ALUMINUM UPRIGHTS

Order No.	Joint Size	Upright Dimensions
1003-A4T	A	1/4" x 3/4"
1003-A6T	A	3/16" x 3/4"
1003-B4T	B	1/4" x 5/8"
1003-B6T	B	3/16" x 5/8"

MODEL 1003 WITH ROUND EDGE STAINLESS STEEL UPRIGHTS

Order No.	Joint Size	Upright Dimensions
1003-A6S	A	3/16" x 3/4"
1003-B6S	B	3/16" x 5/8"

MODEL 1003 WITH ROUND EDGE TITANIUM UPRIGHTS

Order No.	Joint Size	Upright Dimensions
1003-A6TI	A	3/16" x 3/4"

MODEL 1003 WITH CONTOURED LOWER JOINT UNITS

The Automatic Spring Lever knee joint may be purchased with pre-contoured lower joint units for improved cosmesis. Contoured joints are fully compatible with the straight joints illustrated on the preceding page. The following anterior view photos illustrate the combinations possible.

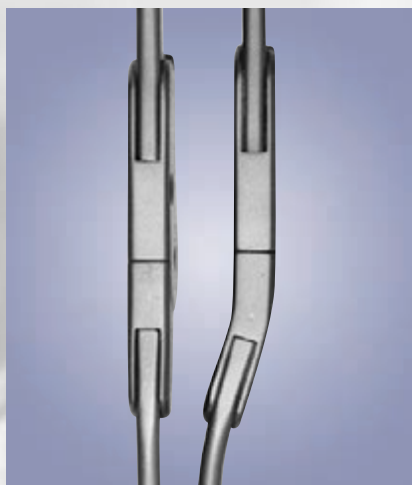

Right Medial Contoured.
Right Lateral Straight.
Code Letter "R".



Left Medial Contoured.
Left Lateral Straight.
Code Letter "L".



Both Medial and Lateral Contoured.
Code Letter "B".

CONTOURED MODEL 1003 WITH ROUND EDGE ALUMINUM UPRIGHTS

Order No.	Joint Size	Upright Dimensions	Contoured Side
1003-A4R	A	1/4" x 3/4"	Right Medial
1003-A4L	A	1/4" x 3/4"	Left Medial
1003-A4B	A	1/4" x 3/4"	Both
1003-A6R	A	3/16" x 3/4"	Right Medial
1003-A6L	A	3/16" x 3/4"	Left Medial
1003-A6B	A	3/16" x 3/4"	Both
1003-B4R	B	1/4" x 5/8"	Right Medial
1003-B4L	B	1/4" x 5/8"	Left Medial
1003-B4B	B	1/4" x 5/8"	Both
1003-B6R	B	3/16" x 5/8"	Right Medial
1003-B6L	B	3/16" x 5/8"	Left Medial
1003-B6B	B	3/16" x 5/8"	Both

CONTOURED MODEL 1003 WITH SQUARE EDGE ALUMINUM UPRIGHTS

Order No.	Joint Size	Upright Dimensions	Contoured Side
1003-A4TR	A	1/4" x 3/4"	Right Medial
1003-A4TL	A	1/4" x 3/4"	Left Medial
1003-A4TB	A	1/4" x 3/4"	Both
1003-A6TR	A	3/16" x 3/4"	Right Medial
1003-A6TL	A	3/16" x 3/4"	Left Medial
1003-A6TB	A	3/16" x 3/4"	Both
1003-B4TR	B	1/4" x 5/8"	Right Medial
1003-B4TL	B	1/4" x 5/8"	Left Medial
1003-B4TB	B	1/4" x 5/8"	Both
1003-B6TR	B	3/16" x 5/8"	Right Medial
1003-B6TL	B	3/16" x 5/8"	Left Medial
1003-B6TB	B	3/16" x 5/8"	Both

CONTOURED MODEL 1003 WITH ROUND EDGE TITANIUM UPRIGHTS

Order No.	Joint Size	Upright Dimensions	Contoured Side
1003-A6TIR	A	3/16" x 3/4"	Right Medial
1003-A6TIL	A	3/16" x 3/4"	Left Medial
1003-A6TIB	A	3/16" x 3/4"	Both

CONTOURED MODEL 1003 WITH ROUND EDGE STAINLESS STEEL UPRIGHTS

Order No.	Joint Size	Upright Dimensions	Contoured Side
1003-A6SR	A	3/16" x 3/4"	Right Medial
1003-A6SL	A	3/16" x 3/4"	Left Medial
1003-A6SB	A	3/16" x 3/4"	Both
1003-B6SR	B	3/16" x 5/8"	Right Medial
1003-B6SL	B	3/16" x 5/8"	Left Medial
1003-B6SB	B	3/16" x 5/8"	Both

MODEL 1004 POSTERIOR OFFSET LEVER LOCK KNEE JOINT

Becker Orthopedic introduced model 1004 in 1964. The design objective was to create a knee joint with the axis of motion located posteriorly to the upright bars.

NOTE: Please follow lever fitting instructions in our Technical Catalog.

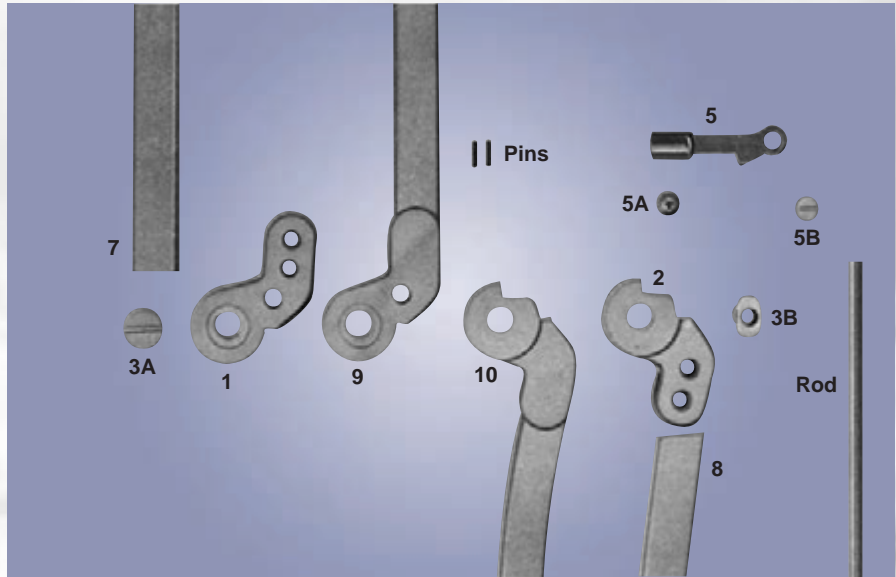

To order parts, please specify the order number, right or left, medial or lateral, followed by the part number desired.

MODEL 1004 WITH ROUND EDGE ALUMINUM UPRIGHTS

Order No.	Joint Size	Upright Dimensions
1004-A4	A	1/4" x 3/4"
1004-A6	A	3/16" x 3/4"
1004-B4	B	1/4" x 5/8"
1004-B6	B	3/16" x 5/8"

MODEL 1004 WITH SQUARE EDGE ALUMINUM UPRIGHTS

Order No.	Joint Size	Upright Dimensions
1004-A4T	A	1/4" x 3/4"
1004-A6T	A	3/16" x 3/4"
1004-B4T	B	1/4" x 5/8"
1004-B6T	B	3/16" x 5/8"

MODEL 1004 WITH ROUND EDGE STAINLESS STEEL UPRIGHTS

Order No.	Joint Size	Upright Dimensions
1004-A6S	A	3/16" x 3/4"
1004-B6S	B	3/16" x 5/8"

MODEL 1004 WITH ROUND EDGE TITANIUM UPRIGHTS

Order No.	Joint Size	Upright Dimensions
1004-A6TI	A	3/16" x 3/4"

- Shipped fully assembled
- Posterior axis of motion
- **Do not remove medial or lateral lock**



MODELS MX-002-101 AND MX-005-101 URETHANE LEVER LOCK ASSIST STRAP

Transforms a standard lever into an automatic locking system.

NOTE: For ordering information please see page 4.4.3.

MODEL 1004 WITH CONTOURED LOWER JOINT UNITS

The Posterior Offset Lever Lock knee joint may be purchased with pre-contoured lower joint units for improved cosmesis. Contoured joints are fully compatible with the straight joints illustrated on the preceding page. The following anterior view photos illustrate the combinations possible.



Right Medial Contoured.
Right Lateral Straight.
Code Letter "R".



Left Medial Contoured.
Left Lateral Straight.
Code Letter "L".



Both Medial and Lateral Contoured.
Code Letter "B".

CONTOURED MODEL 1004 WITH ROUND EDGE ALUMINUM UPRIGHTS

Order No.	Joint Size	Upright Dimensions	Contoured Side
1004-A4R	A	1/4" x 3/4"	Right Medial
1004-A4L	A	1/4" x 3/4"	Left Medial
1004-A4B	A	1/4" x 3/4"	Both
1004-A6R	A	3/16" x 3/4"	Right Medial
1004-A6L	A	3/16" x 3/4"	Left Medial
1004-A6B	A	3/16" x 3/4"	Both
1004-B4R	B	1/4" x 5/8"	Right Medial
1004-B4L	B	1/4" x 5/8"	Left Medial
1004-B4B	B	1/4" x 5/8"	Both
1004-B6R	B	3/16" x 5/8"	Right Medial
1004-B6L	B	3/16" x 5/8"	Left Medial
1004-B6B	B	3/16" x 5/8"	Both

CONTOURED MODEL 1004 WITH SQUARE EDGE ALUMINUM UPRIGHTS

Order No.	Joint Size	Upright Dimensions	Contoured Side
1004-A4TR	A	1/4" x 3/4"	Right Medial
1004-A4TL	A	1/4" x 3/4"	Left Medial
1004-A4TB	A	1/4" x 3/4"	Both
1004-A6TR	A	3/16" x 3/4"	Right Medial
1004-A6TL	A	3/16" x 3/4"	Left Medial
1004-A6TB	A	3/16" x 3/4"	Both
1004-B4TR	B	1/4" x 5/8"	Right Medial
1004-B4TL	B	1/4" x 5/8"	Left Medial
1004-B4TB	B	1/4" x 5/8"	Both
1004-B6TR	B	3/16" x 5/8"	Right Medial
1004-B6TL	B	3/16" x 5/8"	Left Medial
1004-B6TB	B	3/16" x 5/8"	Both

CONTOURED MODEL 1004 WITH ROUND EDGE TITANIUM UPRIGHTS

Order No.	Joint Size	Upright Dimensions	Contoured Side
1004-A6TIR	A	3/16" x 3/4"	Right Medial
1004-A6TIL	A	3/16" x 3/4"	Left Medial
1004-A6TIB	A	3/16" x 3/4"	Both

CONTOURED MODEL 1004 WITH ROUND EDGE STAINLESS STEEL UPRIGHTS

Order No.	Joint Size	Upright Dimensions	Contoured Side
1004-A6SR	A	3/16" x 3/4"	Right Medial
1004-A6SL	A	3/16" x 3/4"	Left Medial
1004-A6SB	A	3/16" x 3/4"	Both
1004-B6SR	B	3/16" x 5/8"	Right Medial
1004-B6SL	B	3/16" x 5/8"	Left Medial
1004-B6SB	B	3/16" x 5/8"	Both

MODEL 1005 FREE MOTION KNEE JOINT

The Becker free motion knee joint has a 180° extension stop.

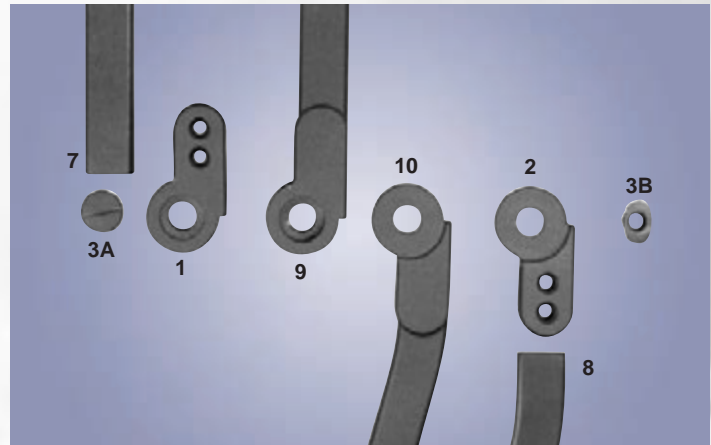

To order parts, please specify the order number, right or left, medial or lateral, followed by the part number desired.

MODEL 1005 WITH ROUND EDGE ALUMINUM UPRIGHTS

Order No.	Joint Size	Upright Dimensions
1005-A4	A	1/4" x 3/4"
1005-A6	A	3/16" x 3/4"
1005-B6	B	3/16" x 5/8"
1005-C6	C	3/16" x 1/2"
1005-C8	C	1/8" x 1/2"

MODEL 1005 WITH SQUARE EDGE ALUMINUM UPRIGHTS

Order No.	Joint Size	Upright Dimensions
1005-A4T	A	1/4" x 3/4"
1005-A6T	A	3/16" x 3/4"
1005-B6T	B	3/16" x 5/8"
1005-C6T	C	3/16" x 1/2"
1005-C8T	C	1/8" x 1/2"

MODEL 1005 WITH ROUND EDGE STAINLESS STEEL UPRIGHTS

Order No.	Joint Size	Upright Dimensions
1005-A2S	A	5/32" x 3/4"
1005-A6S	A	3/16" x 3/4"
1005-B2S	B	5/32" x 5/8"
1005-B6S	B	3/16" x 5/8"
1005-C6S	C	3/16" x 1/2"
1005-C8S	C	1/8" x 1/2"

MODEL 1005 WITH ROUND EDGE TITANIUM UPRIGHTS

Order No.	Joint Size	Upright Dimensions
1005-A6TI	A	3/16" x 3/4"

- Shipped fully assembled

MODEL 1006 ADJUSTABLE EXTENSION RING LOCK KNEE JOINT

Otto K. Becker, Sr. invented the adjustable extension knee joint in 1959. By using a serrated disc, the orthotist may increase or decrease the knee extension angle by 6° intervals. This joint is highly recommended for patients with knee flexion contractures.

MODEL 1006 WITH ROUND EDGE ALUMINUM UPRIGHTS

Order No.	Joint Size	Upright Dimensions
1006-A4	A	1/4" x 3/4"
1006-A6	A	3/16" x 3/4"
1006-B4	B	1/4" x 5/8"
1006-B6	B	3/16" x 5/8"
1006-C6	C	3/16" x 1/2"
1006-C8	C	1/8" x 1/2"

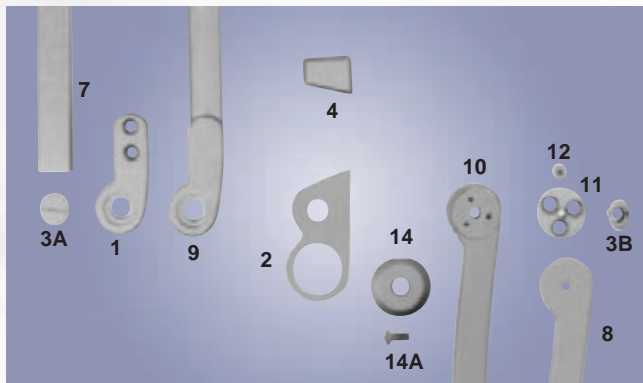

MODEL 1006 WITH ROUND EDGE STAINLESS STEEL UPRIGHTS

Order No.	Joint Size	Upright Dimensions
1006-A2S	A	5/32" x 3/4"
1006-A6S	A	3/16" x 3/4"
1006-B2S	B	5/32" x 5/8"
1006-B6S	B	3/16" x 5/8"
1006-C6S	C	3/16" x 1/2"
1006-C8S	C	1/8" x 1/2"

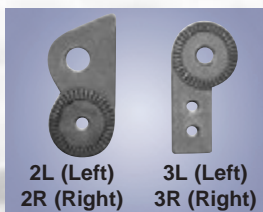

C size

To order parts, please specify the order number, right or left, medial or lateral, followed by the part number desired.

NOTE: Part number 2 is made from 410 stainless steel.



- Shipped fully assembled
- **Do not remove medial or lateral ring**

MODEL 1007 ADJUSTABLE EXTENSION AUTOMATIC SPRING LEVER KNEE JOINT

This joint is functionally the same as the model 1006, but uses a spring loaded lever lock to lock the joint at full extension. **NOTE: Please follow lever fitting instructions in our Technical Catalog.**

MODEL 1007 WITH ROUND EDGE ALUMINUM UPRIGHTS

Order No.	Joint Size	Upright Dimensions
1007-A4	A	1/4" x 3/4"
1007-A6	A	3/16" x 3/4"
1007-B4	B	1/4" x 5/8"
1007-B6	B	3/16" x 5/8"

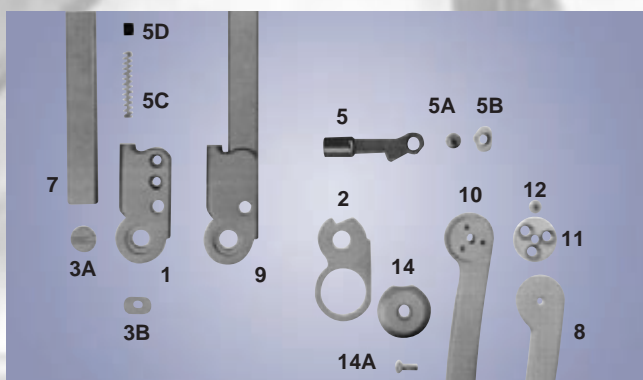

MODEL 1007 WITH ROUND EDGE STAINLESS STEEL UPRIGHTS

Order No.	Joint Size	Upright Dimensions
1007-A6S	A	3/16" x 3/4"
1007-B6S	B	3/16" x 5/8"

To order parts, please specify the order number, right or left, medial or lateral, followed by the part number desired.



- Shipped fully assembled
- **Do not remove medial or lateral lock**

NOTE: Model 1007 may be used with our Lever Release System, please see page 4.4.3 for details.

MODEL 1008 POSTERIOR OFFSET FREE MOTION KNEE JOINT

Model 1008 was developed to create a knee joint with the axis of motion located posteriorly to the upright bars. Model 1008 is fully interchangeable with our posterior offset ring lock (model 1012). Therefore, it may easily be converted to a ring lock by ordering the model 1012 rings. The joints illustrated on this page are fully compatible with the contoured joints shown on the following page.



- Shipped fully assembled
- Posterior axis of motion
- Infant sized joints have no lower joint unit; the distal upright is machined to fit into the upper joint unit

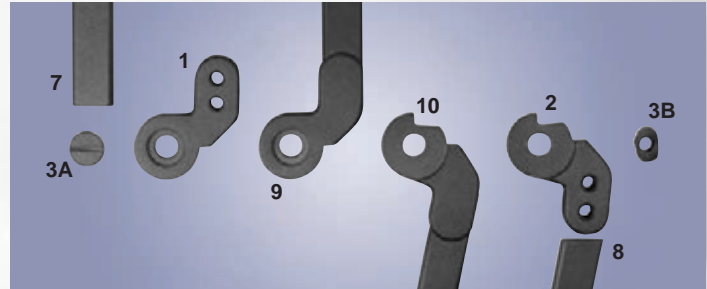

To order parts, please specify the order number, right or left, medial or lateral, followed by the part number desired.

MODEL 1008 WITH ROUND EDGE ALUMINUM UPRIGHTS

Order No.	Joint Size	Upright Dimensions
1008-A4	A	1/4" x 3/4"
1008-A6	A	3/16" x 3/4"
1008-B4	B	1/4" x 5/8"
1008-B6	B	3/16" x 5/8"
1008-C6	C	3/16" x 1/2"
1008-C8	C	1/8" x 1/2"
1008-I8	I	1/8" x 1/2"

MODEL 1008 WITH SQUARE EDGE ALUMINUM UPRIGHTS

Order No.	Joint Size	Upright Dimensions
1008-A4T	A	1/4" x 3/4"
1008-A6T	A	3/16" x 3/4"
1008-B4T	B	1/4" x 5/8"
1008-B6T	B	3/16" x 5/8"
1008-C6T	C	3/16" x 1/2"
1008-C8T	C	1/8" x 1/2"
1008-I8T	I	1/8" x 1/2"

MODEL 1008 WITH ROUND EDGE STAINLESS STEEL UPRIGHTS

Order No.	Joint Size	Upright Dimensions
1008-A6S	A	3/16" x 3/4"
1008-B6S	B	3/16" x 5/8"
1008-C6S	B	3/16" x 1/2"
1008-C8S	C	1/8" x 1/2"
1008-I8S	I	1/8" x 1/2"

MODEL 1008 WITH ROUND EDGE TITANIUM UPRIGHTS

Order No.	Joint Size	Upright Dimensions
1008-A6TI	A	3/16" x 3/4"

MODEL 1008 WITH CONTOURED LOWER JOINT UNITS

The Posterior Offset Free Motion knee joint may be purchased with pre-contoured lower joint units for improved cosmesis. Contoured joints are fully compatible with the straight joints illustrated on the preceding page. The following anterior view photos illustrate the combinations possible.



Right Medial Contoured.
Right Lateral Straight.
Code Letter "R".



Left Medial Contoured.
Left Lateral Straight.
Code Letter "L".



Both Medial and Lateral Contoured.
Code Letter "B".

CONTOURED MODEL 1008 WITH ROUND EDGE ALUMINUM UPRIGHTS

Order No.	Joint Size	Upright Dimensions	Contoured Side
1008-A4R	A	1/4" x 3/4"	Right Medial
1008-A4L	A	1/4" x 3/4"	Left Medial
1008-A4B	A	1/4" x 3/4"	Both
1008-A6R	A	3/16" x 3/4"	Right Medial
1008-A6L	A	3/16" x 3/4"	Left Medial
1008-A6B	A	3/16" x 3/4"	Both
1008-B4R	B	1/4" x 5/8"	Right Medial
1008-B4L	B	1/4" x 5/8"	Left Medial
1008-B4B	B	1/4" x 5/8"	Both
1008-B6R	B	3/16" x 5/8"	Right Medial
1008-B6L	B	3/16" x 5/8"	Left Medial
1008-B6B	B	3/16" x 5/8"	Both

CONTOURED MODEL 1008 WITH SQUARE EDGE ALUMINUM UPRIGHTS

Order No.	Joint Size	Upright Dimensions	Contoured Side
1008-A4TR	A	1/4" x 3/4"	Right Medial
1008-A4TL	A	1/4" x 3/4"	Left Medial
1008-A4TB	A	1/4" x 3/4"	Both
1008-A6TR	A	3/16" x 3/4"	Right Medial
1008-A6TL	A	3/16" x 3/4"	Left Medial
1008-A6TB	A	3/16" x 3/4"	Both
1008-B4TR	B	1/4" x 5/8"	Right Medial
1008-B4TL	B	1/4" x 5/8"	Left Medial
1008-B4TB	B	1/4" x 5/8"	Both
1008-B6TR	B	3/16" x 5/8"	Right Medial
1008-B6TL	B	3/16" x 5/8"	Left Medial
1008-B6TB	B	3/16" x 5/8"	Both

CONTOURED MODEL 1008 WITH ROUND EDGE TITANIUM UPRIGHTS

Order No.	Joint Size	Upright Dimensions	Contoured Side
1008-A6TIR	A	3/16" x 3/4"	Right Medial
1008-A6TIL	A	3/16" x 3/4"	Left Medial
1008-A6TIB	A	3/16" x 3/4"	Both

CONTOURED MODEL 1008 WITH ROUND EDGE STAINLESS STEEL UPRIGHTS

Order No.	Joint Size	Upright Dimensions	Contoured Side
1008-A6SR	A	3/16" x 3/4"	Right Medial
1008-A6SL	A	3/16" x 3/4"	Left Medial
1008-A6SB	A	3/16" x 3/4"	Both
1008-B6SR	B	3/16" x 5/8"	Right Medial
1008-B6SL	B	3/16" x 5/8"	Left Medial
1008-B6SB	B	3/16" x 5/8"	Both

MODEL 1009 POLYCENTRIC FREE MOTION KNEE JOINT

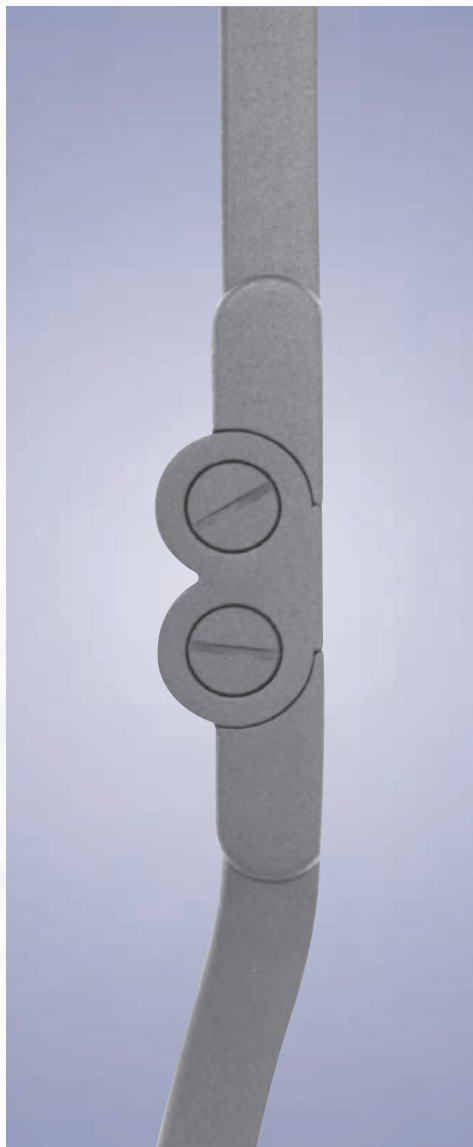

Becker Polycentric knee joints are made with stainless steel midsections for increased durability and strength. This joint may be used with Scott-Stops to limit knee flexion and extension.

Note: Our 1009 "C" size joints are also available with 160° and 170° midsection stops. Please contact our customer service department for details.

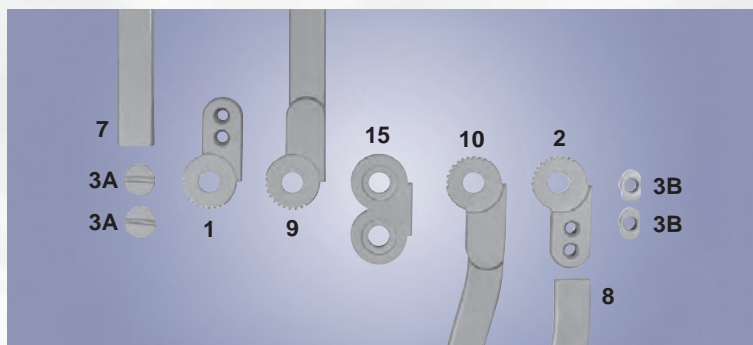

To order parts, please specify the order number, right or left, medial or lateral, followed by the part number desired.

MODEL 1009 WITH ROUND EDGE ALUMINUM UPRIGHTS

Order No.	Joint Size	Upright Dimensions
1009-A4	A	1/4" x 3/4"
1009-A6	A	3/16" x 3/4"
1009-B6	B	3/16" x 5/8"
1009-C6	C	3/16" x 1/2"
1009-C8	C	1/8" x 1/2"

MODEL 1009 WITH SQUARE EDGE ALUMINUM UPRIGHTS

Order No.	Joint Size	Upright Dimensions
1009-A4T	A	1/4" x 3/4"
1009-A6T	A	3/16" x 3/4"
1009-B6T	B	3/16" x 5/8"
1009-C6T	C	3/16" x 1/2"
1009-C8T	C	1/8" x 1/2"

MODEL 1009 WITH ROUND EDGE STAINLESS STEEL UPRIGHTS

Order No.	Joint Size	Upright Dimensions
1009-A6S	A	3/16" x 3/4"
1009-B6S	B	3/16" x 5/8"
1009-C6S	C	3/16" x 1/2"
1009-C8S	C	1/8" x 1/2"

MODEL 1009 WITH ROUND EDGE TITANIUM UPRIGHTS

Order No.	Joint Size	Upright Dimensions
1009-A6TI	A	3/16" x 3/4"

- Shipped fully assembled
- Stainless steel midsections
- May be used with Scott-Stops



MODEL SC-43 SCOTT-STOPS

Scott-Stops were developed by Darryl Womack, CO for adjustable flexion and extension control with a polycentric knee joint. Sold in pairs, they are available in stainless steel in all sizes.

Note: Scott-Stops must be worn medially and laterally.

Order No.	Joint Size
SC-43A	A
SC-43B	B
SC-43C	C
SC-43CA (Aluminum)	C

NOTE: "C" size shown

MODEL 1010

ADJUSTABLE EXTENSION/FLEXION RING LOCK KNEE JOINT

This joint was developed in collaboration with Paul De La Torre, CPO. It provides the orthotist with an extension stop in 6° intervals as well as an adjustable flexion stop in 19° intervals (A and B), or 23.75° intervals (C).

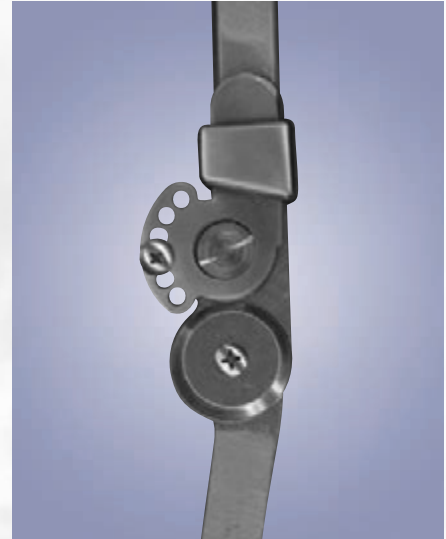
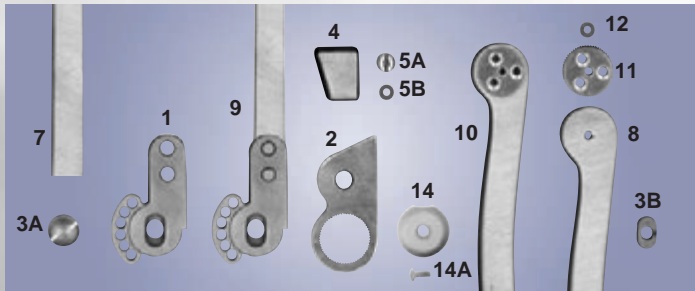

To order parts, please specify the order number, right or left, medial or lateral, followed by the part number desired. "C" Size

MODEL 1010 WITH ROUND EDGE ALUMINUM UPRIGHTS

Order No.	Joint Size	Upright Dimensions
1010-A4	A	1/4" x 3/4"
1010-A6	A	3/16" x 3/4"
1010-B4	B	1/4" x 5/8"
1010-B6	B	3/16" x 5/8"
1010-C6	C	3/16" x 1/2"
1010-C8	C	1/8" x 1/2"

MODEL 1010 WITH ROUND EDGE STAINLESS STEEL UPRIGHTS

Order No.	Joint Size	Upright Dimensions
1010-A6S	A	3/16" x 3/4"
1010-B6S	B	3/16" x 5/8"
1010-C6S	C	3/16" x 1/2"
1010-C8S	C	1/8" x 1/2"

- Shipped fully assembled
 - **Do not remove medial or lateral ring**
- NOTE: Do not use this joint unilaterally**

MODEL 1011

AUTOMATIC TRIGGER LOCK KNEE JOINT

Model 1011 functions like our model 1003. The locking tip is attached by a cable to a trigger allowing the patient to disengage the locks without bending over.

NOTE: Please follow Trigger Lock fitting instructions in our Technical Catalog.

MODEL 1011 WITH ROUND EDGE ALUMINUM UPRIGHTS

Order No.	Joint Size	Upright Dimensions
1011-A4	A	1/4" x 3/4"
1011-A6	A	3/16" x 3/4"
1011-B4	B	1/4" x 5/8"
1011-B6	B	3/16" x 5/8"

MODEL 1011 WITH ROUND EDGE STAINLESS STEEL UPRIGHTS

Order No.	Joint Size	Upright Dimensions
1011-A6S	A	3/16" x 3/4"
1011-B6S	B	3/16" x 5/8"

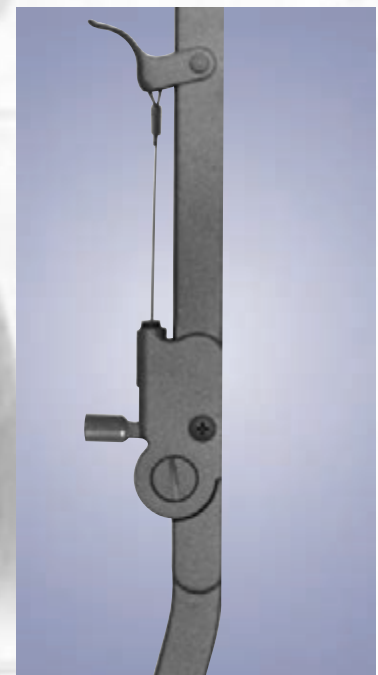
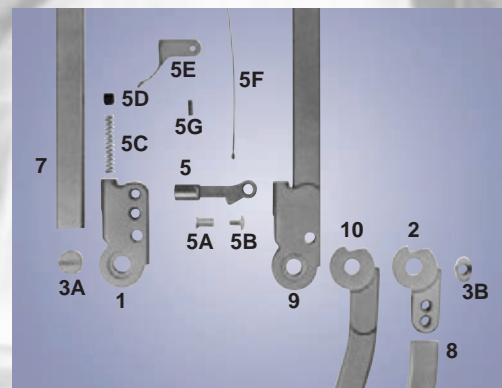

To order parts, please specify the order number, right or left, medial or lateral, followed by the part number desired.

- Shipped fully assembled
- **Do not remove medial or lateral lock**

Note: Model 1011 is also available with square edge aluminum or 3/16" x 3/4" titanium uprights.

MODEL 1012

POSTERIOR OFFSET RING LOCK KNEE JOINT

The axis of motion in model 1012 is offset posteriorly from the upright bars. The joints illustrated on this page are fully compatible with the contoured joints shown on the following page. Model 1012 is the same as model 1008 but with ring locks.

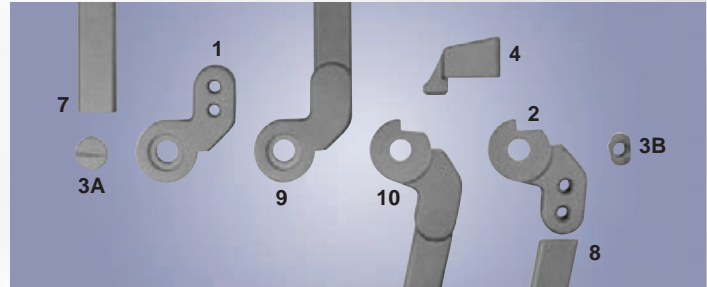

To order parts, please specify the order number, right or left, medial or lateral, followed by the part number desired.

MODEL 1012 WITH ROUND EDGE ALUMINUM UPRIGHTS

Order No.	Joint Size	Upright Dimensions
1012-A4	A	1/4" x 3/4"
1012-A6	A	3/16" x 3/4"
1012-B4	B	1/4" x 5/8"
1012-B6	B	3/16" x 5/8"
1012-C6	C	3/16" x 1/2"
1012-C8	C	1/8" x 1/2"
1012-I8	I	1/8" x 1/2"

MODEL 1012 WITH SQUARE EDGE ALUMINUM UPRIGHTS

Order No.	Joint Size	Upright Dimensions
1012-A4T	A	1/4" x 3/4"
1012-A6T	A	3/16" x 3/4"
1012-B4T	B	1/4" x 5/8"
1012-B6T	B	3/16" x 5/8"
1012-C6T	C	3/16" x 1/2"
1012-C8T	C	1/8" x 1/2"
1012-I8T	I	1/8" x 1/2"

MODEL 1012 WITH ROUND EDGE STAINLESS STEEL UPRIGHTS

Order No.	Joint Size	Upright Dimensions
1012-A6S	A	3/16" x 3/4"
1012-B6S	B	3/16" x 5/8"
1012-C6S	B	3/16" x 1/2"
1012-C8S	C	1/8" x 1/2"
1012-I8S	I	1/8" x 1/2"

MODEL 1012 WITH ROUND EDGE TITANIUM UPRIGHTS

Order No.	Joint Size	Upright Dimensions
1012-A6TI	A	3/16" x 3/4"

- Shipped fully assembled
- Posterior axis of motion
- Infant sized joints have no lower joint unit; the distal upright is machined to fit into the upper joint unit.

• *Do not remove medial or lateral ring*

MODEL 1012 WITH CONTOURED LOWER JOINT UNITS

The Posterior Offset Ring Lock knee joint may be purchased with pre-contoured lower joint units for improved cosmesis. Contoured joints are fully compatible with the straight joints illustrated on the preceding page. The following anterior view photos illustrate the combinations possible.



Right Medial Contoured.
Right Lateral Straight.
Code Letter "R".



Left Medial Contoured.
Left Lateral Straight.
Code Letter "L".



Both Medial and Lateral Contoured.
Code Letter "B".

CONTOURED MODEL 1012 WITH ROUND EDGE ALUMINUM UPRIGHTS

Order No.	Joint Size	Upright Dimensions	Contoured Side
1012-A4R	A	1/4" x 3/4"	Right Medial
1012-A4L	A	1/4" x 3/4"	Left Medial
1012-A4B	A	1/4" x 3/4"	Both
1012-A6R	A	3/16" x 3/4"	Right Medial
1012-A6L	A	3/16" x 3/4"	Left Medial
1012-A6B	A	3/16" x 3/4"	Both
1012-B4R	B	1/4" x 5/8"	Right Medial
1012-B4L	B	1/4" x 5/8"	Left Medial
1012-B4B	B	1/4" x 5/8"	Both
1012-B6R	B	3/16" x 5/8"	Right Medial
1012-B6L	B	3/16" x 5/8"	Left Medial
1012-B6B	B	3/16" x 5/8"	Both

CONTOURED MODEL 1012 WITH SQUARE EDGE ALUMINUM UPRIGHTS

Order No.	Joint Size	Upright Dimensions	Contoured Side
1012-A4TR	A	1/4" x 3/4"	Right Medial
1012-A4TL	A	1/4" x 3/4"	Left Medial
1012-A4TB	A	1/4" x 3/4"	Both
1012-A6TR	A	3/16" x 3/4"	Right Medial
1012-A6TL	A	3/16" x 3/4"	Left Medial
1012-A6TB	A	3/16" x 3/4"	Both
1012-B4TR	B	1/4" x 5/8"	Right Medial
1012-B4TL	B	1/4" x 5/8"	Left Medial
1012-B4TB	B	1/4" x 5/8"	Both
1012-B6TR	B	3/16" x 5/8"	Right Medial
1012-B6TL	B	3/16" x 5/8"	Left Medial
1012-B6TB	B	3/16" x 5/8"	Both

CONTOURED MODEL 1012 WITH ROUND EDGE TITANIUM UPRIGHTS

Order No.	Joint Size	Upright Dimensions	Contoured Side
1012-A6TIR	A	3/16" x 3/4"	Right Medial
1012-A6TIL	A	3/16" x 3/4"	Left Medial
1012-A6TIB	A	3/16" x 3/4"	Both

CONTOURED MODEL 1012 WITH ROUND EDGE STAINLESS STEEL UPRIGHTS

Order No.	Joint Size	Upright Dimensions	Contoured Side
1012-A6SR	A	3/16" x 3/4"	Right Medial
1012-A6SL	A	3/16" x 3/4"	Left Medial
1012-A6SB	A	3/16" x 3/4"	Both
1012-B6SR	B	3/16" x 5/8"	Right Medial
1012-B6SL	B	3/16" x 5/8"	Left Medial
1012-B6SB	B	3/16" x 5/8"	Both

MODEL 1014 RATCHET LOCK™ KNEE JOINT

The Ratchet Lock™ is designed to promote full knee extension by providing knee stability to the user through an incremental range of knee flexion. The joint features a secure, semi-automatic locking mechanism that can be quickly and easily disengaged. The lock may also be completely disengaged to facilitate sitting until the user decides to re-engage the locking mechanism.

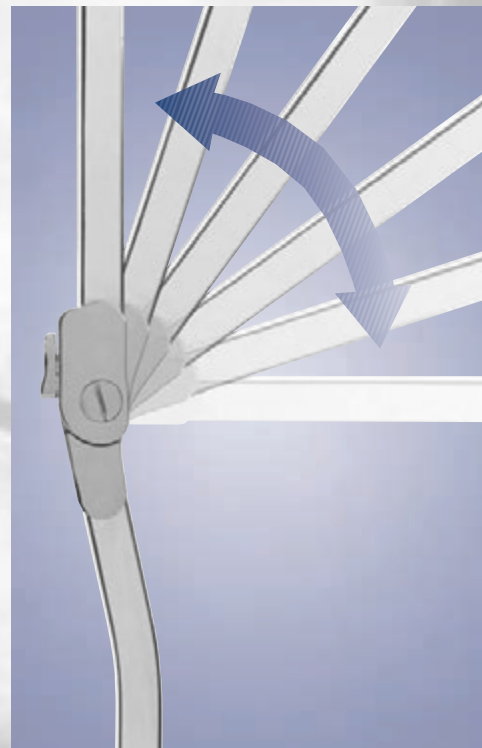

Distinctive, anterior, low profile locking mechanism.

Incremental range of knee flexion.

MODEL 1014 WITH ROUND EDGE ALUMINUM UPRIGHTS

Order No.	Joint Size	Upright Dimensions
1014-A6	A	3/16" x 3/4"
1014-B6	B	3/16" x 5/8"
1014-C6	C	3/16" x 1/2"

MODEL 1014 WITH ROUND EDGE STAINLESS STEEL UPRIGHTS

Order No.	Joint Size	Upright Dimensions
1014-A6S	A	3/16" x 3/4"
1014-B6S	B	3/16" x 5/8"
1014-C6S	C	3/16" x 1/2"

MODEL 1014 WITH ROUND EDGE TITANIUM UPRIGHTS

Order No.	Joint Size	Upright Dimensions
1014-A6TI	A	3/16" x 3/4"

- Shipped fully assembled
- Heavy Duty Lever Release System may be added, please see page 4.4.3.
- Servicing of this knee joint must be done by Becker Orthopedic

WEIGHTS LIMITS

Joint Size		
A	B	C
< 160#	< 120#	< 60#

MODEL 1015 KEY LOCK™ KNEE JOINT

Model 1015 is the same as our model 1014 except the ratcheting mechanism has been replaced with a free motion distal joint unit that automatically locks upon reaching full knee extension.

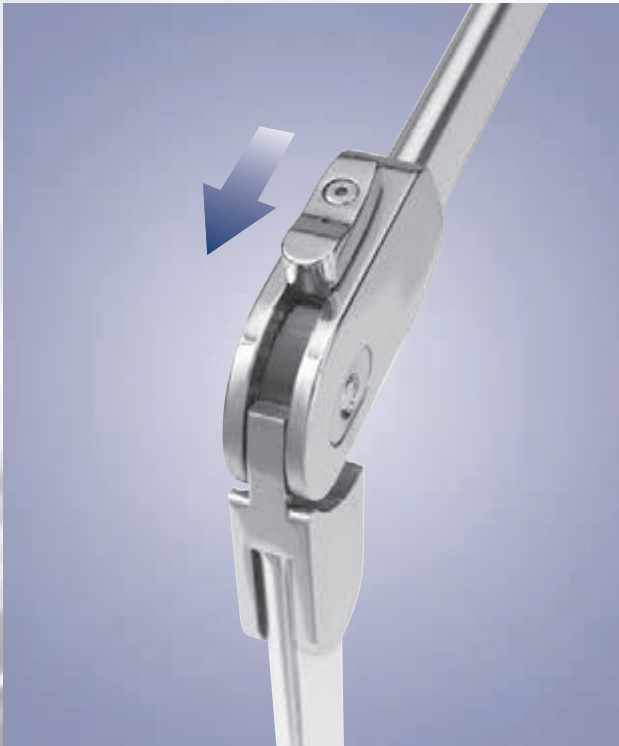

Free motion

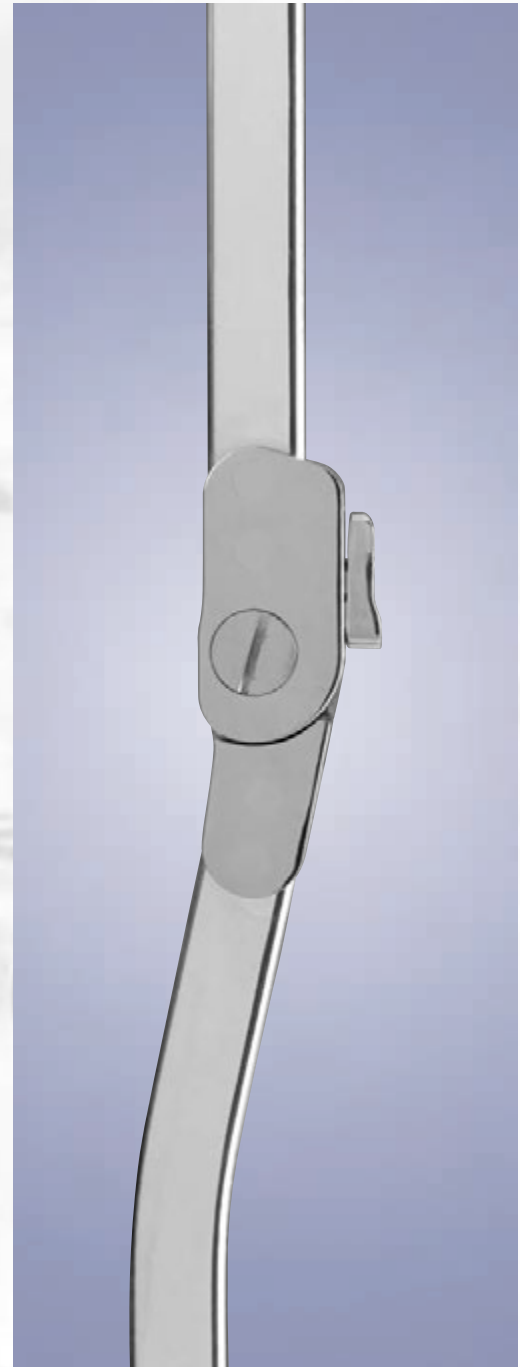

MODEL 1015 WITH ROUND EDGE ALUMINUM UPRIGHTS

Order No.	Joint Size	Upright Dimensions
1015-A6	A	3/16" x 3/4"
1015-B6	B	3/16" x 5/8"
1015-C6	C	3/16" x 1/2"

MODEL 1015 WITH ROUND EDGE STAINLESS STEEL UPRIGHTS

Order No.	Joint Size	Upright Dimensions
1015-A6S	A	3/16" x 3/4"
1015-B6S	B	3/16" x 5/8"
1015-C6S	C	3/16" x 1/2"

MODEL 1015 WITH ROUND EDGE TITANIUM UPRIGHTS

Order No.	Joint Size	Upright Dimensions
1015-A6TI	A	3/16" x 3/4"

- Shipped fully assembled
- Heavy Duty Lever Release System may be added, please see page 4.4.3.

MODEL 1016 TRICKNEE

Model 1016 was developed for individuals with moderate quadricep weakness. The spring arrangement provides force to resist flexion during weight bearing and assist extension during swing phase. Adjustments can be made to aid in creating a smoother, more uniform gait. It is available with aluminum or stainless steel uprights in straight or contoured models. **NOTE: Some assembly is required in your facility. Please follow the lever fitting instructions enclosed with joints, or refer to our Technical Catalog. Model 1016 is not available with ball catches.**

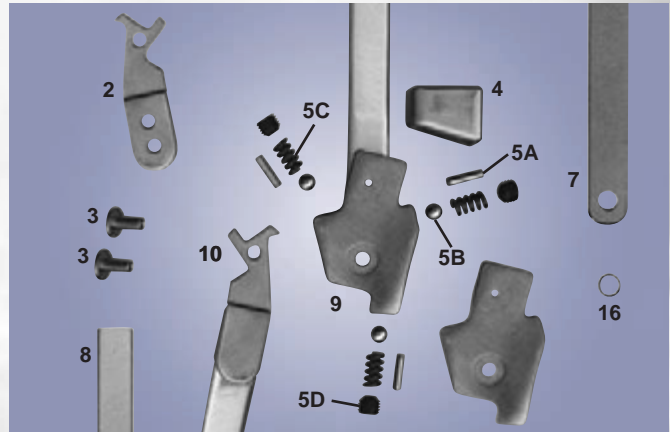
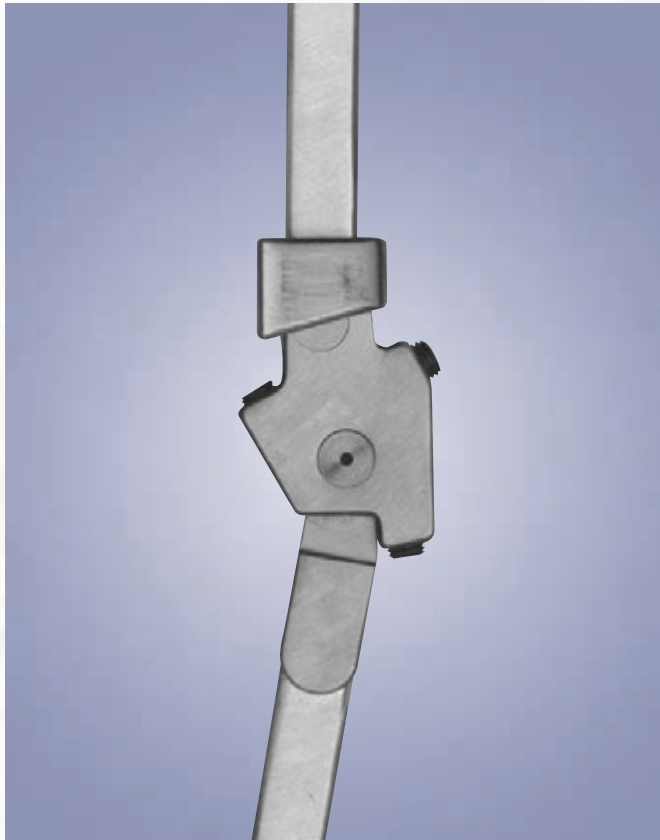

To order parts, please specify the order number, right or left, medial or lateral, followed by the part number desired. **Note: Part number 16 is only necessary on models with aluminum uprights.**

MODEL 1016 WITH ROUND EDGE ALUMINUM UPRIGHTS

Order No.	Upright Dimensions
1016-B4	1/4" x 5/8"
1016-B6	3/16" x 5/8"

MODEL 1016 WITH SQUARE EDGE ALUMINUM UPRIGHTS

Order No.	Upright Dimensions
1016-B4T	1/4" x 5/8"
1016-B6T	3/16" x 5/8"

MODEL 1016 WITH ROUND EDGE STAINLESS STEEL UPRIGHTS

Order No.	Upright Dimensions
1016-B6S	3/16" x 5/8"

CONTOURED MODEL 1016 WITH ROUND EDGE ALUMINUM UPRIGHTS

Order No.	Upright Dimensions	Contoured Side
1016-B4R	1/4" x 5/8"	Right Medial
1016-B4L	1/4" x 5/8"	Left Medial
1016-B4B	1/4" x 5/8"	Both
1016-B6R	3/16" x 5/8"	Right Medial
1016-B6L	3/16" x 5/8"	Left Medial
1016-B6B	3/16" x 5/8"	Both

CONTOURED MODEL 1016 WITH ROUND EDGE STAINLESS STEEL UPRIGHTS

Order No.	Upright Dimensions	Contoured Side
1016-B6SR	3/16" x 5/8"	Right Medial
1016-B6SL	3/16" x 5/8"	Left Medial
1016-B6SB	3/16" x 5/8"	Both

- Shipped fully assembled
- Posterior axis of motion
- **Do not remove medial or lateral ring**

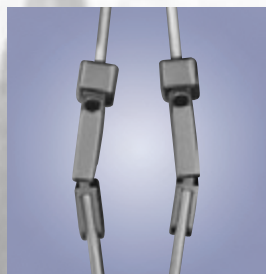

Both medial and lateral contour

CONTOURED MODEL 1016 WITH SQUARE EDGE ALUMINUM UPRIGHTS

Order No.	Upright Dimensions	Contoured Side
1016-B4TR	1/4" x 5/8"	Right Medial
1016-B4TL	1/4" x 5/8"	Left Medial
1016-B4TB	1/4" x 5/8"	Both
1016-B6TR	3/16" x 5/8"	Right Medial
1016-B6TL	3/16" x 5/8"	Left Medial
1016-B6TB	3/16" x 5/8"	Both

MODEL 1600 SINGLE AXIS FREE MOTION OVERLAP KNEE JOINT

Model 1600 is an Overlap Free Motion knee joint with a rivet.

MODEL 1600 WITH ROUND EDGE ALUMINUM UPRIGHTS

Order No.	Joint Size	Upright Dimension
1600-A	A	1/8" x 5/8"

MODEL 1600 WITH ROUND EDGE STAINLESS STEEL UPRIGHTS

Order No.	Joint Size	Upright Dimension
1600-S	A	3/32" x 5/8"



MODEL 1700 ADJUSTABLE POSITIONING JOINT

This joint design was suggested to us by Sid Johnson, CO of Orange, California. The degree of extension may be set in 9° intervals and locked. This joint is ideal for any upper or lower limb positioning orthosis.

MODEL 1700 WITH ROUND EDGE ALUMINUM UPRIGHTS

Order No.	Joint Size	Upright Dimensions
1700-B6	B	3/16" x 5/8"
1700-C6	C	3/16" x 1/2"
1700-C8	C	1/8" x 1/2"

MODEL 1700 WITH ROUND EDGE STAINLESS STEEL UPRIGHTS

Order No.	Joint Size	Upright Dimensions
1700-B2S	B	5/32" x 5/8"
1700-B6S	B	3/16" x 5/8"
1700-C6S	C	3/16" x 1/2"
1700-C8S	C	1/8" x 1/2"



MODEL S1700 ADJUSTABLE POSITIONING JOINT WITH STRAIGHT LOWER BAR

MODEL S1700 WITH ROUND EDGE ALUMINUM UPRIGHTS

Order No.	Joint Size	Upright Dimensions
S1700-B6	B	3/16" x 5/8"
S1700-C6	C	3/16" x 1/2"
S1700-C8	C	1/8" x 1/2"

MODEL S1700 WITH ROUND EDGE STAINLESS STEEL UPRIGHTS

Order No.	Joint Size	Upright Dimensions
S1700-B2S	B	5/32" x 5/8"
S1700-B6S	B	3/16" x 5/8"
S1700-C6S	C	3/16" x 1/2"
S1700-C8S	C	1/8" x 1/2"

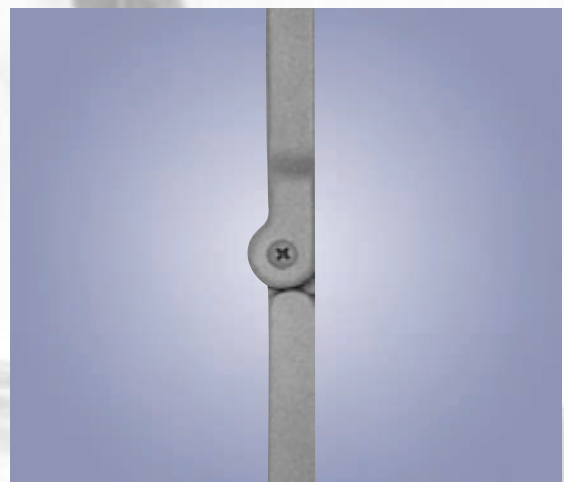

MODEL 1800 VARILOC® POSITIONING JOINT

The Variloc® Positioning Joint is an adjustable locking rotary joint that can be positioned in 10° increments. The joint is positively engaged by high strength locking pins, which can be instantly disengaged by a push-button mechanism, allowing the joint to rotate. **NOTE: The Variloc® cannot be used as a free-motion joint.**

US Patent 5,689,999

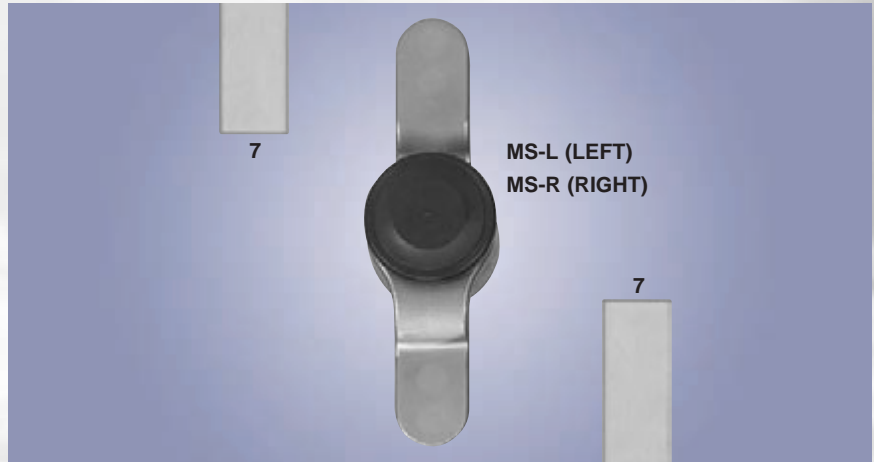
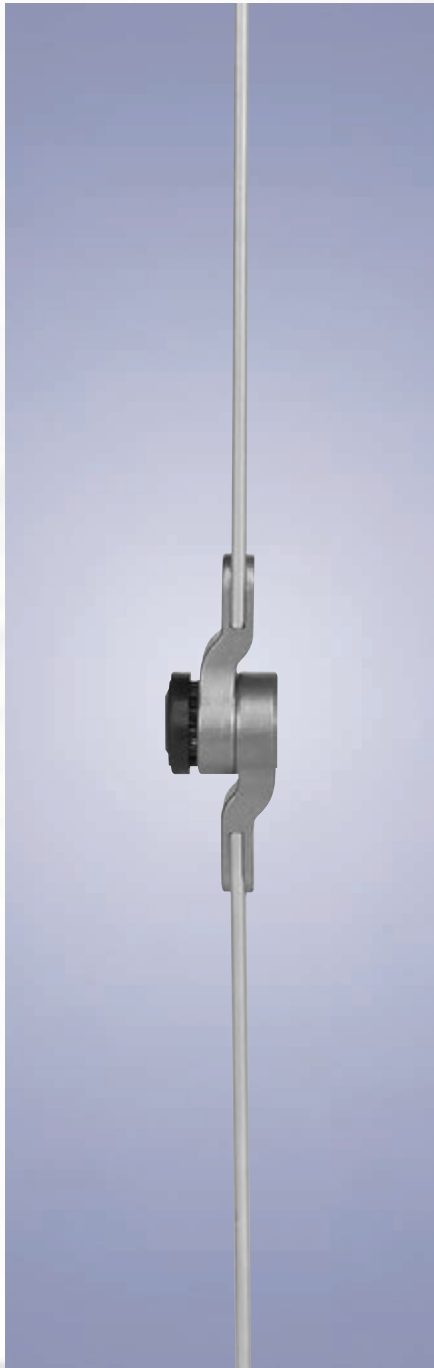

To order parts, please specify the order number, right or left, medial or lateral, followed by the part number desired. **NOTE: For medial joint replacement parts, please refer to model 1005-A6 on page 4.1.10. For proximal and distal upright replacements, please use part number 7.**

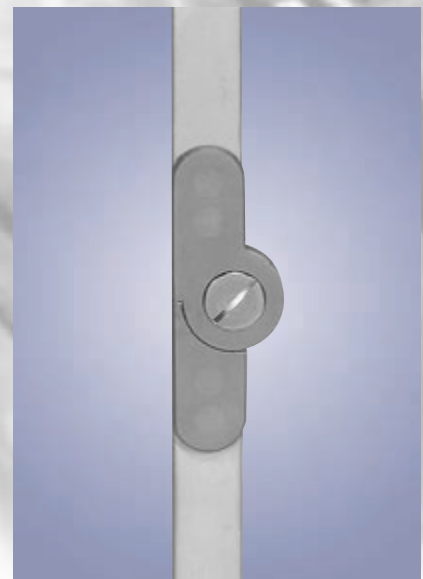
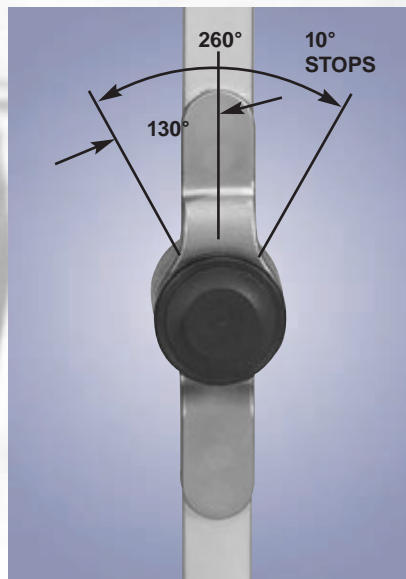

Variloc® Positioning Joint

Free Motion Medial Joint

- Shipped fully assembled
- Sold individually or in pairs

Order No.	Upright Dimensions	Material
1800-A6	3/16" x 3/4"	Aluminum
1800-A6S	3/16" x 3/4"	Stainless Steel
1800-A6TI	3/16" x 3/4"	Titanium

MODEL 1900 MONODOS® JOINT

The Monodos® Joint was designed in collaboration with William P. Bunnell, M.D. The joint incorporates a one-way clutch that allows rotation in one direction, but blocks all rotation in the opposite direction until the clutch is released. The Monodos® can be used for flexion or extension contractures and is a cost-effective alternative to serial casting. The joint has a variety of clinical applications, including Cerebral Palsy, spinal cord injuries and stroke.

US Patent 5,328,446

NOTE: The Monodos® Joint should not be used in weight-bearing applications.



- Shipped unassembled
- Modular upright design
- May be used for the right or left leg

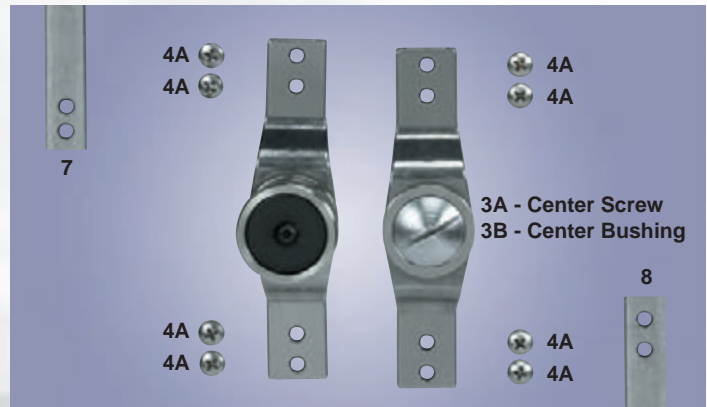

To order parts, please specify the order number, right or left, medial or lateral, followed by the part number desired.

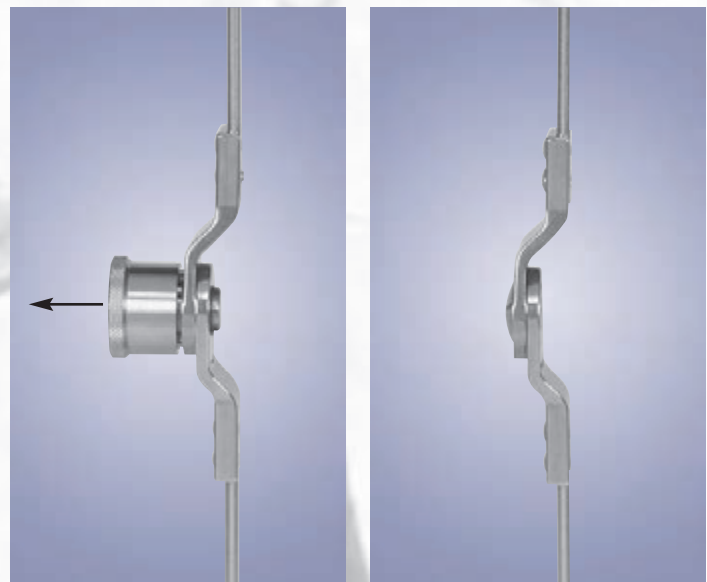

Monodos® Joint

Free Motion Medial Joint

Order No.	Description	Unit	Upright Dimensions
1900-AA	Monodos® Knee Joint-Aluminum	Pair	3/16" x 5/8"
1900-ALA	Monodos® Knee Joint-Lateral Side Only-Aluminum	Each	3/16" x 5/8"
1900-ALS	Monodos® Knee Joint-Lateral Side Only-Stainless Steel	Each	3/16" x 5/8"
1900-AS	Monodos® Knee Joint-Stainless Steel	Pair	3/16" x 5/8"
1900-AMA	Monodos® Knee Joint-Medial Side Only-Aluminum	Each	3/16" x 5/8"
1900-AMS	Monodos® Knee Joint-Medial Side Only-Stainless Steel	Each	3/16" x 5/8"

NOTE: Please see page 1.2.13 for additional Monodos® models

MODEL 1017 AUTOMATIC ANGLED LEVER LOCK

Model 1017 is a modular lever lock knee joint with a locking mechanism that will automatically engage when the joints reach full extension. The modular design increases manufacturing options and allows for easier maintenance of the orthosis. The long angled lever is easily operated by the patient and can be shortened or contoured to suit individual needs. Model 1017 comes with an optional anterior pull-cable that allows the patient to simultaneously disengage both locks by pulling on the cable.

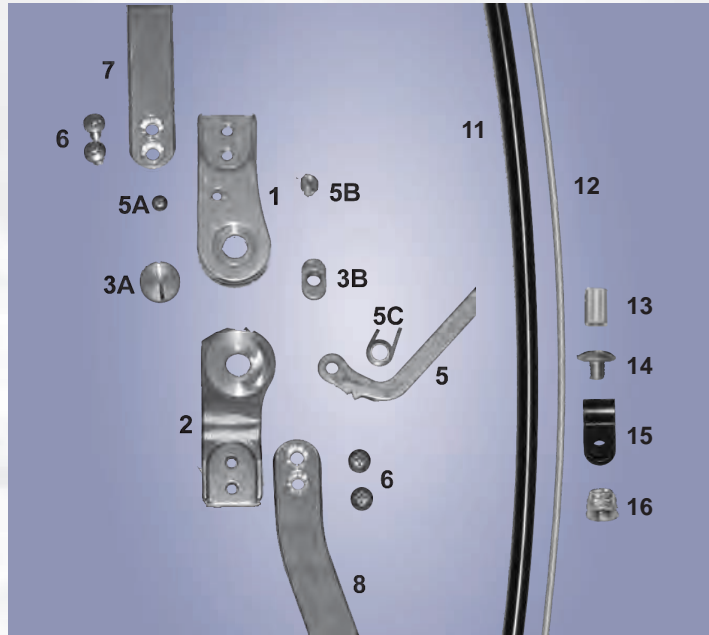

To order parts, please specify the order number, right or left, medial or lateral, followed by the part number desired.

Model 1017 with Round Edge Aluminum Uprights

Order No.	Upright Dimensions	Material
1017-A6	3/16" x 3/4"	Aluminum
1017-B6	3/16" x 5/8"	Aluminum

Model 1017 with Round Edge Stainless Steel Uprights

Order No.	Upright Dimensions	Material
1017-A6S	3/16" x 3/4"	Stainless Steel
1017-B6S	3/16" x 5/8"	Stainless Steel

Model 1017 with Round Edge Titanium Uprights

Order No.	Upright Dimensions	Material
1017-A6TI	3/16" x 3/4"	Titanium

- Shipped fully assembled
- Locking mechanism automatically engages at full extension
- Sold individually or in pairs

SECTION IV

KNEE JOINTS

1000 SERIES

2000 SERIES

9000 SERIES

**KNEE JOINT ACCESSORIES
AND COST SAVING KITS**



2000 SERIES KNEE JOINTS

The 2000 series was added to our product line to create a cost-effective, reliable knee joint. Stainless steel side plates are riveted onto the proximal upright to form the upper joint unit. The distal bar is machined to fit into the upper joint unit. The absence of a lower joint unit allows the orthotist to make a rapid medial contour.

MODEL S2001

RING LOCK KNEE JOINT ASSEMBLED WITH BUSHING AND SCREW



This model comes fully assembled with the flexion set at 180°.

Note: Nylatron washers are only required on models with aluminum uprights.

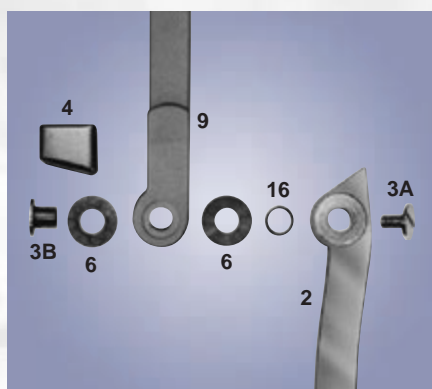

To order parts, please specify the order number, right or left, medial or lateral, followed by the part number desired.

MODEL S2001 WITH ROUND EDGE ALUMINUM UPRIGHTS

Order No.	Joint Size	Upright Dimensions
S2001-A4	A	1/4" x 3/4"
S2001-A6	A	3/16" x 3/4"
S2001-B4	B	1/4" x 5/8"
S2001-B6	B	3/16" x 5/8"
S2001-C6	C	3/16" x 1/2"
S2001-C8	C	1/8" x 1/2"

MODEL S2001 WITH ROUND EDGE STAINLESS STEEL UPRIGHTS

Order No.	Joint Size	Upright Dimensions
S2001-A6S	A	3/16" x 3/4"
S2001-B6S	B	3/16" x 5/8"
S2001-C6S	C	3/16" x 1/2"
S2001-C8S	C	1/8" x 1/2"

• Do not remove medial or lateral ring

MODEL S2005

FREE MOTION KNEE JOINT ASSEMBLED WITH BUSHING AND SCREW



This model is fully assembled with the flexion set at 180°.

Note: Nylatron washers are only required on models with aluminum uprights.

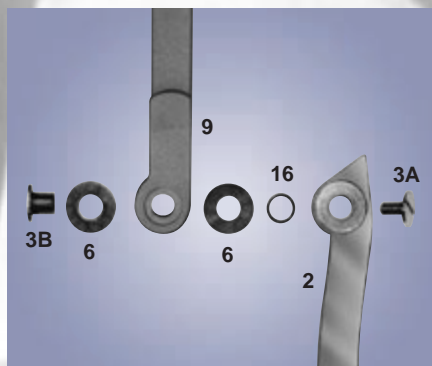

To order parts, please specify the order number, right or left, medial or lateral, followed by the part number desired.

MODEL S2005 WITH ROUND EDGE ALUMINUM UPRIGHTS

Order No.	Joint Size	Upright Dimensions
S2005-A4	A	1/4" x 3/4"
S2005-A6	A	3/16" x 3/4"
S2005-B4	B	1/4" x 5/8"
S2005-B6	B	3/16" x 5/8"
S2005-C6	C	3/16" x 1/2"
S2005-C8	C	1/8" x 1/2"

MODEL S2005 WITH ROUND EDGE STAINLESS STEEL UPRIGHTS

Order No.	Joint Size	Upright Dimensions
S2005-A6S	A	3/16" x 3/4"
S2005-B6S	B	3/16" x 5/8"
S2005-C6S	C	3/16" x 1/2"
S2005-C8S	C	1/8" x 1/2"

MODEL R2001 RING LOCK KNEE JOINT UNASSEMBLED WITH RIVET

This model comes unassembled and requires the distal bar to be shaped.

Note: Nylatron washers are only required on models with aluminum uprights.

MODEL R2001 WITH ROUND EDGE ALUMINUM UPRIGHTS

Order No.	Joint Size	Upright Dimensions
R2001-A4	A	1/4" x 3/4"
R2001-A6	A	3/16" x 3/4"
R2001-B4	B	1/4" x 5/8"
R2001-B6	B	3/16" x 5/8"
R2001-C6	C	3/16" x 1/2"
R2001-C8	C	1/8" x 1/2"

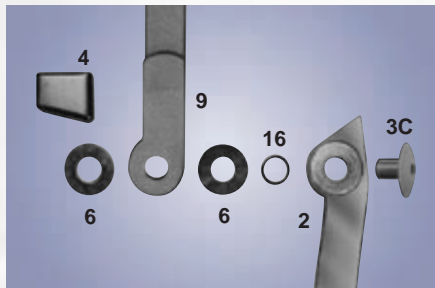

To order parts, please specify the order number, right or left, medial or lateral, followed by the part number desired.



• Do not remove medial or lateral ring

MODEL R2001 WITH ROUND EDGE STAINLESS STEEL UPRIGHTS

Order No.	Joint Size	Upright Dimensions
R2001-A6S	A	3/16" x 3/4"
R2001-B6S	B	3/16" x 5/8"
R2001-C6S	C	3/16" x 1/2"
R2001-C8S	C	1/8" x 1/2"

MODEL R2005 FREE MOTION KNEE JOINT UNASSEMBLED WITH RIVET

This model comes unassembled and requires the distal bar to be shaped.

Note: Nylatron washers are only required on models with aluminum uprights.

MODEL R2005 WITH ROUND EDGE ALUMINUM UPRIGHTS

Order No.	Joint Size	Upright Dimensions
R2005-A4	A	1/4" x 3/4"
R2005-A6	A	3/16" x 3/4"
R2005-B4	B	1/4" x 5/8"
R2005-B6	B	3/16" x 5/8"
R2005-C6	C	3/16" x 1/2"
R2005-C8	C	1/8" x 1/2"

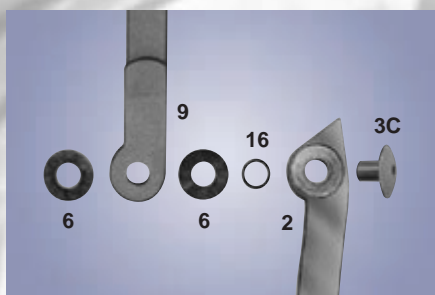

To order parts, please specify the order number, right or left, medial or lateral, followed by the part number desired.



MODEL R2005 WITH ROUND EDGE STAINLESS STEEL UPRIGHTS

Order No.	Joint Size	Upright Dimensions
R2005-A6S	A	3/16" x 3/4"
R2005-B6S	B	3/16" x 5/8"
R2005-C6S	C	3/16" x 1/2"
R2005-C8S	C	1/8" x 1/2"

MODEL S2003 AUTOMATIC RING LOCK KNEE JOINT

Model S2003 was designed to give patients the convenience of an automatic locking device without the bulk of a traditional bail system. When the leg reaches full extension, the rings are automatically engaged by springs that are internally housed within the midsections.

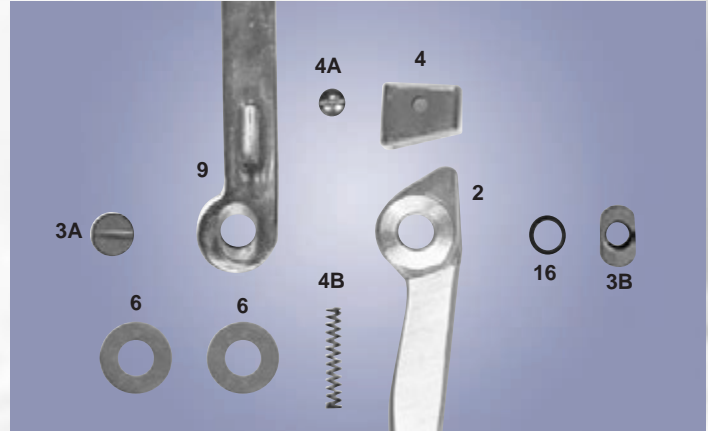

To order parts, please specify the order number, right or left, medial or lateral, followed by the part number desired.

MODEL S2003 WITH ROUND EDGE ALUMINUM UPRIGHTS

Order No.	Joint Size	Upright Dimensions
S2003-A4	A	1/4" x 3/4"
S2003-C6	C	3/16" x 1/2"

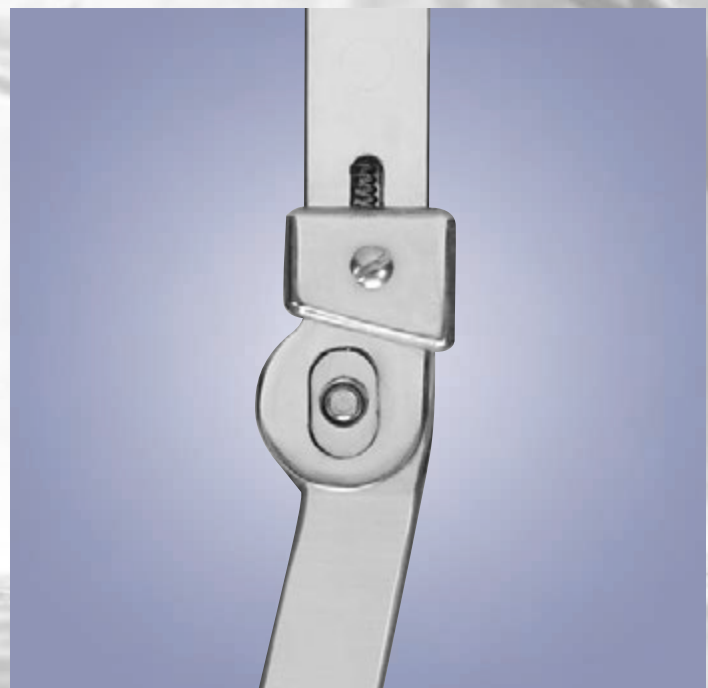

- Shipped fully assembled.
- Rings automatically engage at full extension
- ***Do not remove medial or lateral ring***

Internally housed spring automatically engages ring lock at full extension.

MODEL 2004 EASYFORM KNEE JOINT

The EasyForm knee joint is a low-profile automatic lever lock knee joint that was designed to be used in thermoplastic or laminated orthoses. The EasyForm knee joint is constructed entirely of 1/8" stainless steel and is available in straight, or contoured configurations. Our Lever Release System, model MX-004-001, can be utilized with this joint to replace the standard lever lock.

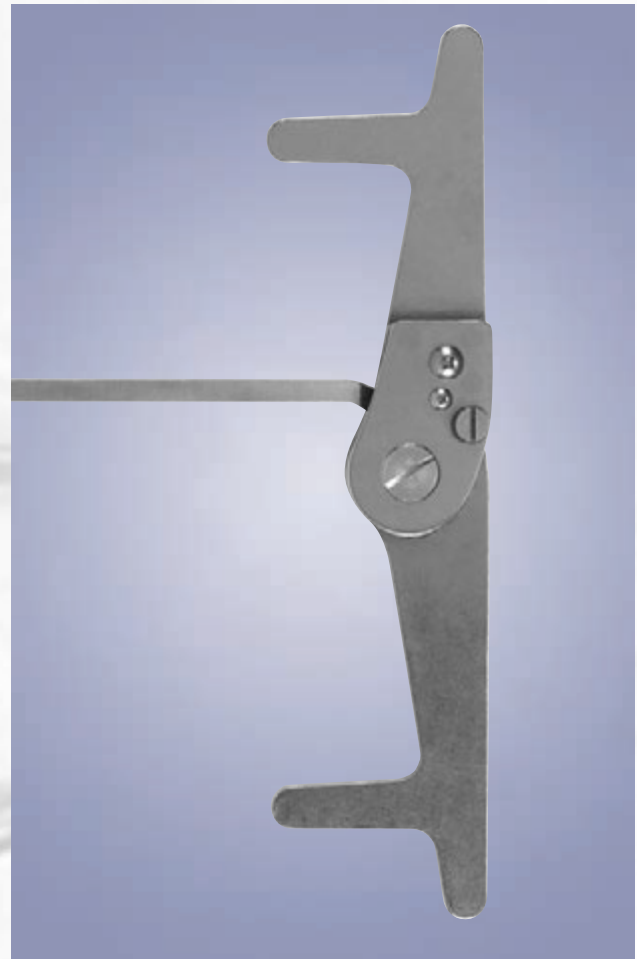
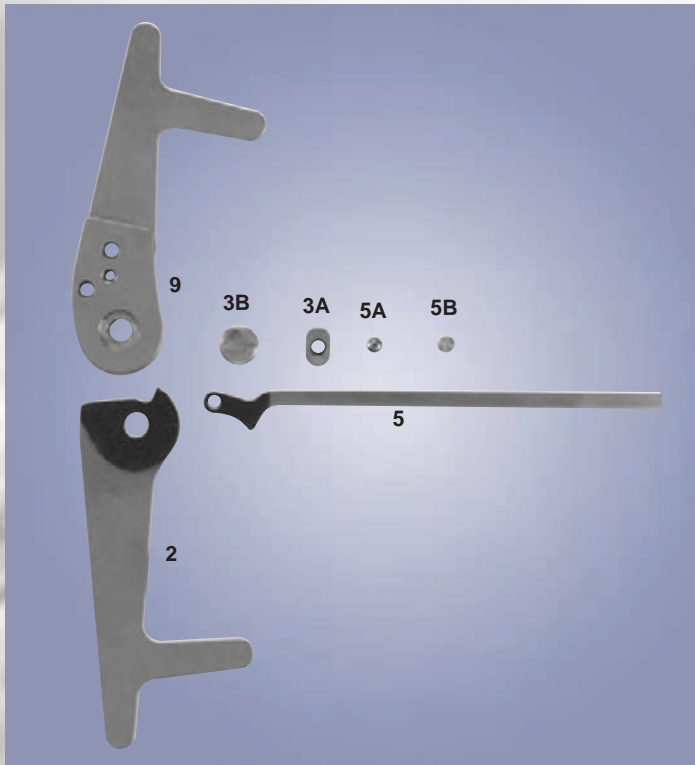

To order parts, please specify the order number, right or left, medial or lateral, followed by the part number desired.

Order No.	Description
2004-B8	Straight
2004-B8R	Right Medial Contour
2004-B8L	Left Medial Contour
2004-B8B	Medial and Lateral Contour
2004-AK	Alignment Kit

- Shipped fully assembled
- ***Do not remove medial or lateral lock***

MODEL MX-004-001 LEVER RELEASE SYSTEM

- Replaces standard lever lock
- Simultaneously unlocks both joints with a single trigger



Note: For ordering information please see page 4.4.3.

MODEL 2009 AUTOMATIC RING LOCK

Model 2009 is a non-protrusion knee joint that combines the simplicity and security of a standard drop lock with automatic locking. When the joints reach full extension the rings are automatically engaged by springs that are internally housed within the midsections. This feature gives the user the convenience of automatic locking.

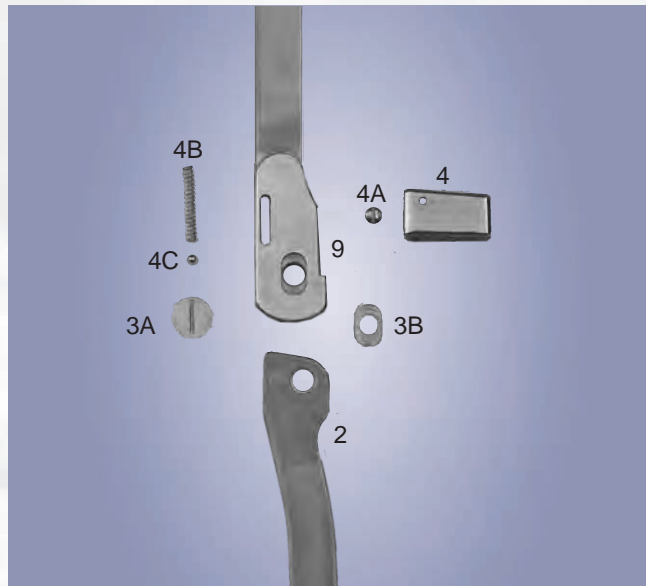
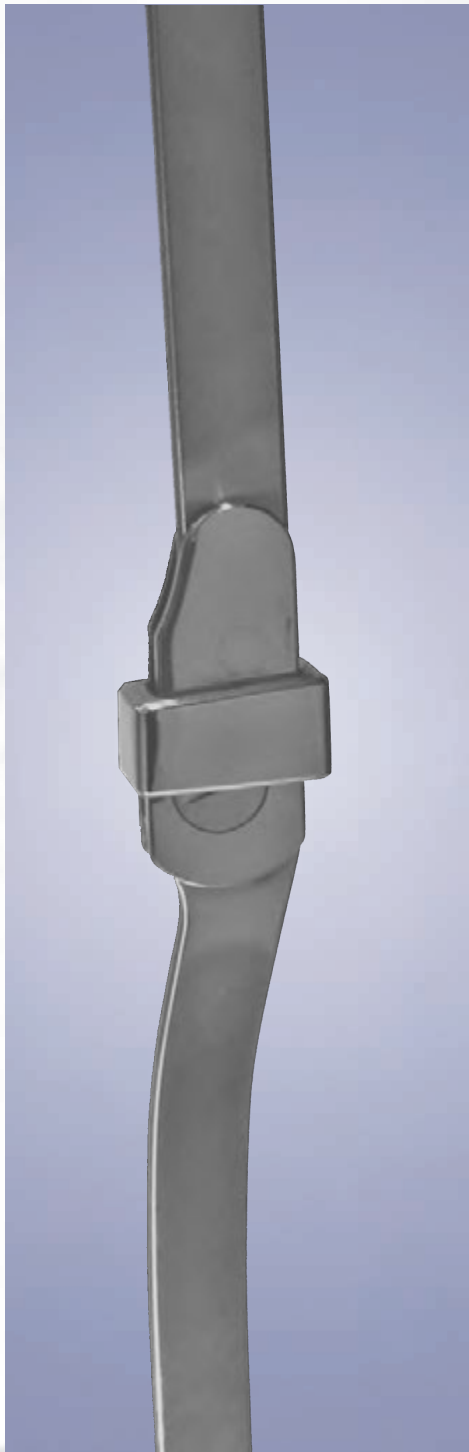

To order parts, please specify the order number, right or left, medial or lateral, followed by the part number desired.

Model 2009 with Round Edge Aluminum Uprights

Order No.	Upright Dimensions	Material
2009-A6	3/16" x 3/4"	Aluminum
2009-B6	3/16" x 5/8"	Aluminum

Model 2009 with Round Edge Stainless Steel Uprights

Order No.	Upright Dimensions	Material
2009-A6S	3/16" x 3/4"	Stainless Steel
2009-B6S	3/16" x 5/8"	Stainless Steel



Internally housed spring automatically engages ring at full extension.

- Shipped fully assembled
- Rings automatically engage at full extension
- **Do not remove medial or lateral ring**

SECTION IV

KNEE JOINTS

1000 SERIES

2000 SERIES

9000 SERIES

**KNEE JOINT ACCESSORIES
AND COST SAVING KITS**



9000 SERIES

MODEL 9001 E-KNEE™

The E-Knee™ is a foot force activated, computer controlled, electromechanical orthotic knee joint. An adjustable pressure sensitive footplate signals the microprocessor to lock the knee joint when pressure is applied and to unlock the knee joint in the absence of pressure. The E-Knee™ comes equipped with a free motion joint for the medial side. Certified and licensed orthotists are required to attend a training seminar to use this product. Please contact our customer service department for registration details on upcoming seminars.

US Patent 6,517,503 and 10,205,714

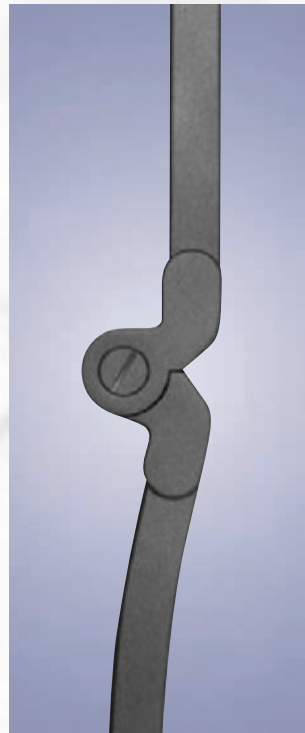

MODEL 9001 WITH ROUND EDGE ALUMINUM UPRIGHTS

Order No.	Joint Size	Upright Dimensions	Side
9001-A6-L	A	3/16" x 3/4"	Left
9001-A6-R	A	3/16" x 3/4"	Right

MODEL 9001 WITH ROUND EDGE STAINLESS STEEL UPRIGHTS

Order No.	Joint Size	Upright Dimensions	Side
9001-A6S-L	A	3/16" x 3/4"	Left
9001-A6S-R	A	3/16" x 3/4"	Right

MODEL 9001 WITH ROUND EDGE TITANIUM UPRIGHTS

Order No.	Joint Size	Upright Dimensions	Side
9001-A6TI-L	A	3/16" x 3/4"	Left
9001-A6TI-R	A	3/16" x 3/4"	Right

E-Knee™

- Shipped without bars attached

Free Motion Medial Joint

- Model 1008



A complete molding dummy kit is provided, free of charge, with your initial E-Knee™ purchase.

- Complete molding dummy kit

MODEL 9001

E-KNEE™ COMPONENT PARTS



E-Knee™ Midsection
Order No. 9001-A6MS
 Please specify left or right when ordering.



E-Knee™ Molding Dummy
Order No. 9001-A6-LD (Left)
9001-A6-RD (Right)



Controller Battery
Order No. 9001-A6-22



Battery Molding Dummy
Order No. 9001-A6-22D



Controller
Order No. 9001-A6-19



Battery Charger
Order No. 9001-A6-50



Foot Sensors
Order No. 9001-A6-18
 Please specify small, large or custom. If custom, please supply tracing.

JOINT COMPONENTS (not pictured)

Order No.	Description
9001-A6-HALF	E-Knee™ Joint with Aluminum Uprights - Please specify left or right
9001-A6S-HALF	E-Knee™ Joint with Stainless Steel Uprights - Please specify left or right
9001-A6TI-HALF	E-Knee™ Joint with Titanium Uprights - Please specify left or right
9001-A6#7	E-Knee™ Proximal Upright only - Aluminum
9001-A6S#7	E-Knee™ Proximal Upright only - Stainless Steel
9001-A6TI#7	E-Knee™ Proximal Upright only - Titanium
9001-A6#8	E-Knee™ Distal Upright only - Aluminum
9001-A6S#8	E-Knee™ Distal Upright only - Stainless Steel
9001-A6TI#8	E-Knee™ Distal Upright only - Titanium
1008-A6-HALF	Medial Joint with Aluminum Uprights - Please specify left or right
1008-A6S-HALF	Medial Joint with Stainless Steel Uprights - Please specify left or right
1008-A6TI-HALF	Medial Joint with Titanium Uprights - Please specify left or right
1008-A6-MAK	1008-A6 Medial Assist Kit

NOTE: To order replacement parts for model 1008, please see page 4.1.12.

MODEL LR-9002 LOAD RESPONSE KNEE JOINT

The Load Response knee joint, model LR-9002, allows 18° of knee flexion during the stance phase of gait. The lateral joint is equipped with a preloaded spiral torsional spring that provides for shock absorption during stance phase knee flexion while maintaining knee joint stability for individuals with quadriceps weakness.

US Patent 6,471,664

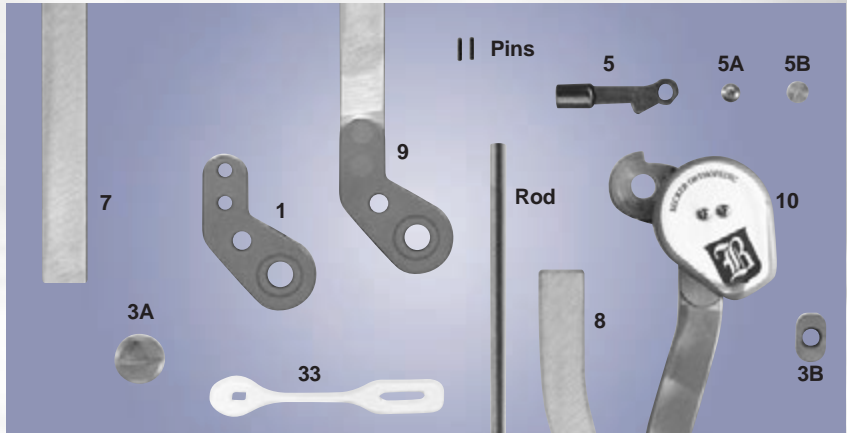
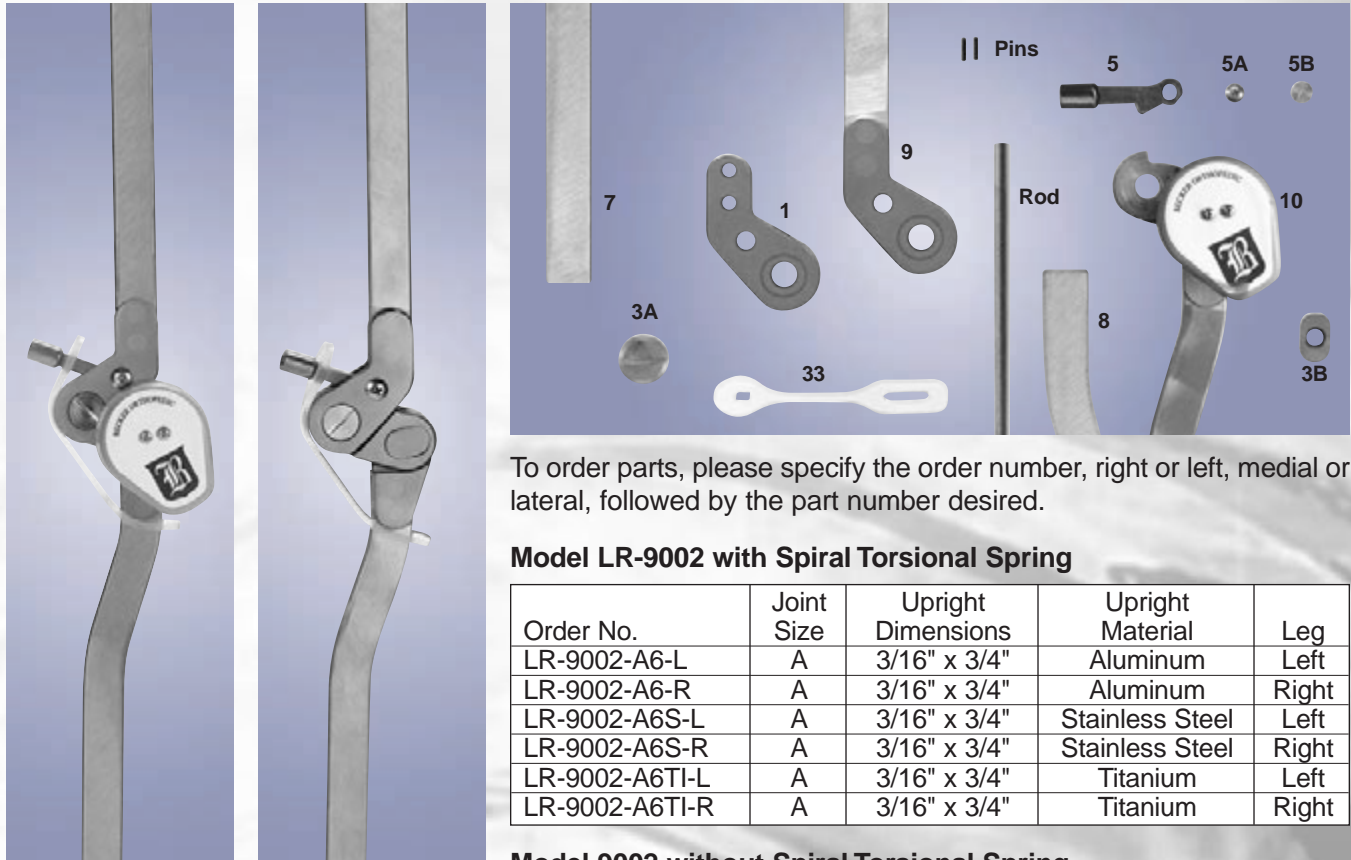

To order parts, please specify the order number, right or left, medial or lateral, followed by the part number desired.

Model LR-9002 with Spiral Torsional Spring

Order No.	Joint Size	Upright Dimensions	Upright Material	Leg
LR-9002-A6-L	A	3/16" x 3/4"	Aluminum	Left
LR-9002-A6-R	A	3/16" x 3/4"	Aluminum	Right
LR-9002-A6S-L	A	3/16" x 3/4"	Stainless Steel	Left
LR-9002-A6S-R	A	3/16" x 3/4"	Stainless Steel	Right
LR-9002-A6TI-L	A	3/16" x 3/4"	Titanium	Left
LR-9002-A6TI-R	A	3/16" x 3/4"	Titanium	Right

Model 9002 without Spiral Torsional Spring

Order No.	Joint Size	Upright Dimensions	Upright Material	Leg
9002-A6-L	A	3/16" x 3/4"	Aluminum	Left
9002-A6-R	A	3/16" x 3/4"	Aluminum	Right
9002-A6S-L	A	3/16" x 3/4"	Stainless Steel	Left
9002-A6S-R	A	3/16" x 3/4"	Stainless Steel	Right
9002-A6TI-L	A	3/16" x 3/4"	Titanium	Left
9002-A6TI-R	A	3/16" x 3/4"	Titanium	Right

Model LR-9002 with Spiral Torsional Spring

- Shipped fully assembled
- Heavy Duty Lever Release System may be added
- Do not remove medial or lateral locks

Model 9002 without Spiral Torsional Spring

MODEL MX-003-HD HEAVY DUTY LEVER RELEASE SYSTEM

- Replaces standard bail rod
- Simultaneously unlocks both joints with a single trigger



NOTE: For ordering information please see page 4.4.3.

MODEL 9000 GX-KNEE

Based on the design of a traditional high-quality Becker knee joint, the GX-Knee comes equipped with a pneumatic spring on the lateral joint to assist with knee extension during the swing phase of gait. A medial knee joint is also included to help control knee alignment.

The GX-Knee is a free motion knee joint that is designed to provide extension assist, not prevent knee flexion.

NOTE: When ordering please specify which GX-Assist option you wish to be included with your knee joint. Available with 125N pneumatic spring (for standard applications), or 175N (for high activity patients). For example, to order a GX-Knee with aluminum uprights for the right leg with 125N, your order number would be 9000-A6-R-125.

MODEL 9000 WITH ROUND EDGE ALUMINUM UPRIGHTS

Order No.	Joint Size	Upright Dimensions	Side
9000-A6-R	A	3/16" x 3/4"	Right
9000-A6-L	A	3/16" x 3/4"	Left
9000-B6-R	B	3/16" x 5/8"	Right
9000-B6-L	B	3/16" x 5/8"	Left

MODEL 9000 WITH SQUARE EDGE ALUMINUM UPRIGHTS

Order No.	Joint Size	Upright Dimensions	Side
9000-A6T-R	A	3/16" x 3/4"	Right
9000-A6T-L	A	3/16" x 3/4"	Left
9000-B6T-R	B	3/16" x 5/8"	Right
9000-B6T-L	B	3/16" x 5/8"	Left

MODEL 9000 WITH ROUND EDGE STAINLESS STEEL UPRIGHTS

Order No.	Joint Size	Upright Dimensions	Side
9000-A6S-R	A	3/16" x 3/4"	Right
9000-A6S-L	A	3/16" x 3/4"	Left
9000-B6S-R	B	3/16" x 5/8"	Right
9000-B6S-L	B	3/16" x 5/8"	Left

MODEL 9000 WITH ROUND EDGE TITANIUM UPRIGHTS

Order No.	Joint Size	Upright Dimensions	Side
9000-A6TI-R	A	3/16" x 3/4"	Right
9000-A6TI-L	A	3/16" x 3/4"	Left



- Available with your choice of a 125N pneumatic spring (for standard applications), or 175N (for high activity patients).
- Free knee with pneumatic extension assist.
- Paired with a medial joint to control knee alignment.

MODEL 9004 UTX® KAFO

The UTX®, model 9004, was designed and developed by Dr. Nils van Leerdam, of Ambroise Holland bv. It is a lightweight, less than two pounds, knee-ankle-foot orthosis that stabilizes the knee during the stance phase of gait but enables knee flexion during swing phase. At the end of swing phase, as the knee reaches full extension, a ratchet engages to stabilize the knee. A cable runs inside the distal side member from the ankle joint to the knee joint. At the end of stance phase, as the ankle dorsiflexes, this cable linkage causes the knee joint to unlock and destabilize the knee.

The UTX® is also available as a non-stance control KAFO model, "Stabil", that locks and unlocks by control of the user. Other models of the UTX® are also available including an "FS" (frontal stability) model to control genu valgum. All UTX® models can be equipped with a medial ankle joint to provide additional control in the coronal and transverse planes.

CLINICAL INDICATIONS:

- Quadriceps weakness as a result of Poliomyelitis, Multiple Sclerosis, CVA, Femoral Nerve and Incomplete Spinal Cord Injuries
- Genu Recurvatum. Use posterior tibial shell for maximum control
- Successful users will typically have hip extensor strength (Power 3) and passive ankle dorsiflexion

CONTRAINDICATIONS FOR UTX® SWING AND FS MODELS:

- Any Spasticity in Hip, Knee or Ankle Musculature
- Patient Weight Over 265 lbs
- Passive Ankle ROM Less than 5° of Dorsiflexion
- Valgus/Varus Instability at the Knee of More than 10°
- Substantial Leg Length Discrepancy where the Affected Side is Shorter



UTX® SWING FEATURES:

- Comfortable to Wear While Sitting Due to the Lack of Rigid Structures on the Posterior Aspect of the Orthosis
- Manual Unlocking Option
- Easy Adjustment of Dorsiflexion



THERMOPLASTIC UTX® SWING FEATURES:

- ThermoPlastic UTX® option affords enhanced control of the foot ankle complex
- Key feature of the ThermoPlastic UTX® is its intimate total contact fit and resultant potential to afford increased control of the limb



UTX® FS FEATURES:

- Comfortable to Wear While Sitting Due to the Lack of Rigid Structures on the Posterior Aspect of the Orthosis
- Manual Unlocking Option
- Controls Genu Valgum
- Easy Adjustment of Dorsiflexion and Stirrup Upright Angle

NOTE: The UTX® is only available through Becker Central Fabrication. Please see pages 2.3.7 and 2.3.8 for details.

SECTION IV

KNEE JOINTS

1000 SERIES

2000 SERIES

9000 SERIES

**KNEE JOINT ACCESSORIES
AND COST SAVING KITS**



KNEE JOINT ACCESSORIES

In over seventy years of serving the orthotic profession, we have received many special requests. Some of these requests are illustrated on this page and the following page. **Special modifications require 24-48 hours.**



MODEL H-BC BALL CATCHES

For an additional charge, we will install ball catches on any of our Ring Lock knee joints, except for the "II" and 1016 models. Ball Catch components are also sold separately.

Order No.	Description
H-BC-HALF	Installation of Ball Catches-Half Pair
H-BC-P	Installation of Ball Catches-Pair

Order No.	Description	For Joint Size
BCB-3/16	Ball Bearing 3/16"	A
BCB-1/8	Ball Bearing 1/8"	B and C
BCS-3/16	Ball Catch Spring 3/16"	A
BCS-1/8	Ball Catch Spring 1/8"	B and C
T-16	Corking Tool 3/16"	A
T-18	Corking Tool 1/8"	B and C

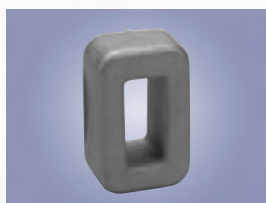

MODEL 1002-A#4HD HEAVY DUTY RINGS

Heavy duty rings are recommended for very large and/or active patients. They can be used on any of our 1002-A size joints.

MODEL K-10 SPECIAL LENGTH UPRIGHTS

If our standard length uprights are not right for your patient, please add this model number to your order. Specify length from knee center, distal or proximal, and left or right when ordering.



MODEL K-2 MIXED KNEE JOINTS

Our system of knee joints allows the orthotist to provide increased strength to a localized area. For example, if you are using model 1001-A knee joints you can order them with 1/4" x 3/4" aluminum proximal uprights and 3/16" x 3/4" stainless steel distal uprights. Please contact our customer service department for assistance.



MODEL K-3 SETTING FLEXION IN THE BARS

The angle of our knee joint uprights can be set to the degree of extension you desire. Please specify the maximum degree of extension when ordering, as well as the degree of flexion distribution in the proximal and distal uprights.



MODEL K-8 STRAIGHT DISTAL UPRIGHTS

Our knee joints have an offset in the distal upright. If you prefer to have it straight, please add this model number to your order.

MODEL D-8 SPRING PULL KIT

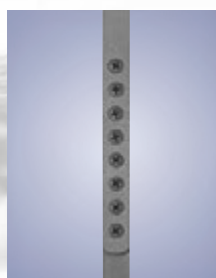
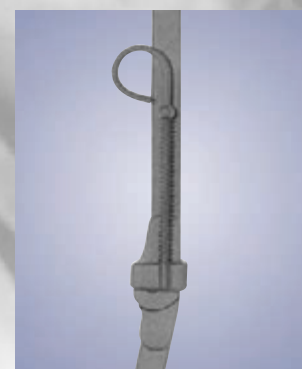

MODEL GA-5 & GA-6 GROWTH ADJUSTMENTS

Order No.	Description
GA-5	Loop Type Growth Adjustment (please specify AK or BK)
GA-6	Lap Type Growth Adjustment (please specify AK or BK) (shown)

MODEL 980 QUICK DISCONNECT™

Developed in collaboration with Tom DiBello, CO, the Quick Disconnect™ allows the orthotist to make any section of an orthosis detachable. For example, the Quick Disconnect™ can be used at the KAFO/AFO interface when the patient needs to wear only the AFO section at night. It is available in nylon or heavy duty aluminum.

US Patent 6,129,689

Order No.	Description
980	Nylon Quick Disconnect™
980-HD	Aluminum Heavy Duty Quick Disconnect™



MODEL MX-002-101 1004-A URETHANE ASSIST STRAP

Model MX-002-101 is a urethane strap that can be incorporated with our model 1004-A size joints to automatically engage the lever locks. Sold individually.



MODEL MX-005-101 1004-B URETHANE ASSIST STRAP

Model MX-005-101 is the same as above except that it is made to be used with our 1004-B size joints. Sold individually.

MODELS MX-003-001 – MX-008-001 LEVER RELEASE SYSTEM

This Lever Release System allows the patient to simultaneously disengage both locks by operating a single, laterally mounted lever.

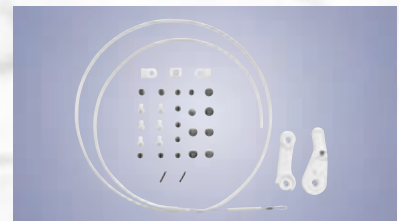

Order No.	Size
MX-003-001	Lever Release Kit for 1003-A/1007-A joints
MX-004-001	Lever Release Kit for 1004-A/2004-B joints
MX-006-001	Lever Release Kit for 1004-B joints
MX-008-001	Lever Release Kit for 1003-B/1007-B joints

For replacement parts, please see Lever Release Kit instructions or contact our customer service department.

MODEL MX-003-HD HEAVY DUTY LEVER RELEASE SYSTEM

Model MX-003-HD is a Heavy Duty Lever Release Kit for models 1003, 1014 and 1015.

Order No.	Size
MX-003-HDS/L	Heavy Duty Lever Release Starter Kit (Left Lateral Attachment)
MX-003-HDS/R	Heavy Duty Lever Release Starter Kit (Right Lateral Attachment)
MX-003-HD/L	Heavy Duty Lever Release Kit (Left Lateral Attachment)
MX-003-HD/R	Heavy Duty Lever Release Kit (Right Lateral Attachment)
MX-003-HD12	Replacement Part Kit
MX-003-HD8	Crimping Tool



For replacement parts, please see Lever Release Kit instructions or contact our customer service department.

COST SAVING KITS

Cost Saving Kits have been designed to minimize inventory costs and simplify ordering.

MODEL KAFO-1002-KIT THE BENEFIT 1002 KAFO KIT

This kit provides everything needed to fabricate a KAFO, except for the leather.



INCLUDES:

- One pair 1002 Modified Ring Lock knee joints
- One pair Slim Line 2825 Double Action ankle joints
- One Slim Line 2900 Stirrup
- Aluminum band material
- Padding for bands
- Aluminum and stainless steel rivets
- Chafes and loops
- Hook and loop



Order No.	Size	Stirrup Size	Upright Dimensions
KAFO-1002-KIT-A	Adult	11", 10-1/2", 10", 9-1/2", 9", 8-1/2", 8"	1/4" x 3/4"
KAFO-1002-KIT-B	Youth	9", 8-1/4", 7-1/2", 6-3/4"	3/16" x 5/8"
KAFO-1002-KIT-C	Child	6-3/4", 6", 5-1/4", 4-1/2"	3/16" x 1/2"

NOTE: Please specify desired stirrup size with each kit, e.g., KAFO-1002-KIT-A10.

MODEL KAFO-R2001-KIT

THE BENEFIT R2001 KAFO KIT

This kit provides everything needed to fabricate a KAFO, except for the leather.

INCLUDES:

- One pair R2001 Ring Lock knee joints
- One pair Slim Line 2825 Double Action ankle joints
- One Slim Line 2900 Stirrup
- Aluminum band material
- Padding for bands
- Aluminum and stainless steel rivets
- Chafes and loops
- Hook and loop

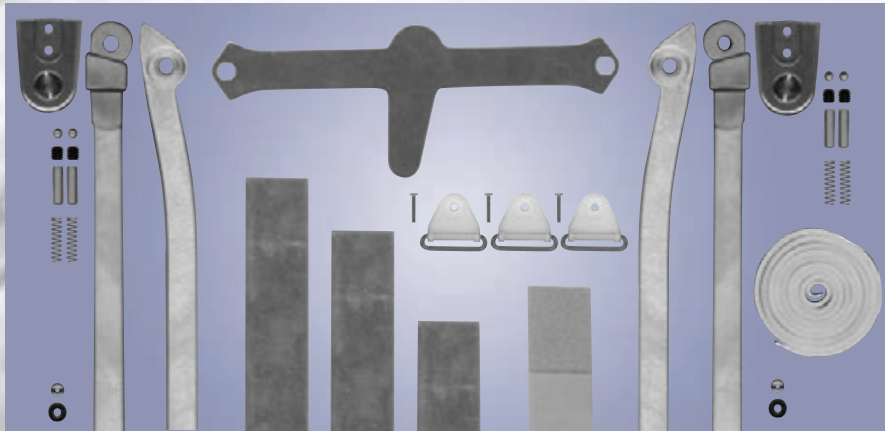

Order No.	Size	Stirrup Size	Upright Dimensions
KAFO-R2001-KIT-A	Adult	11", 10-1/2", 10", 9-1/2", 9", 8-1/2", 8"	1/4" x 3/4"
KAFO-R2001-KIT-B	Youth	9", 8-1/4", 7-1/2", 6-3/4"	3/16" x 5/8"
KAFO-R2001-KIT-C	Child	6-3/4", 6", 5-1/4", 4-1/2"	3/16" x 1/2"

NOTE: Please specify desired stirrup size with each kit, e.g., KAFO-R2001-KIT-A10.

MODEL AFO-KIT THE BENEFIT AFO KIT

This kit provides everything needed to fabricate an AFO, except the leather.



INCLUDES:

- One pair Slim Line double action ankle joints with uprights
- Calf band aluminum
- One Slim Line 2900 Stirrup
- Padding for the calf band
- Stainless steel rivets
- Chafes and loops
- Hook and loop

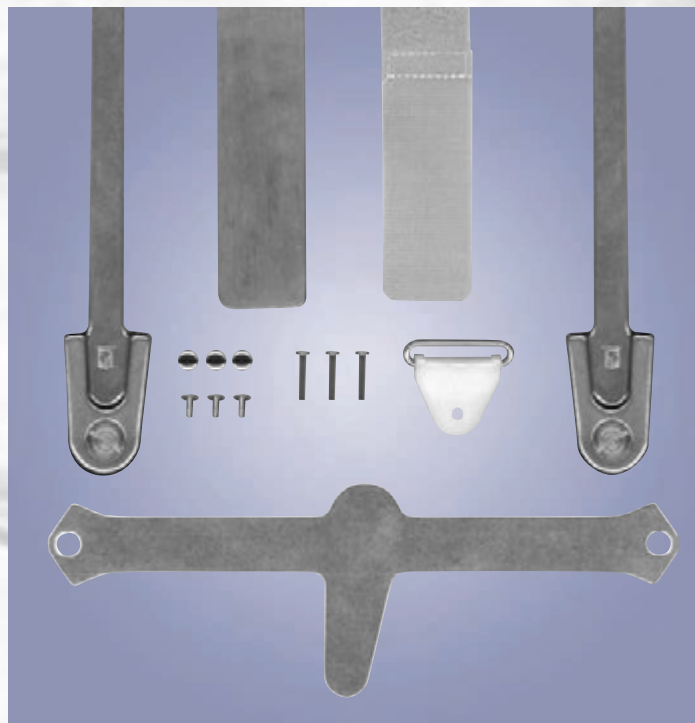

Order No.	Size	Stirrup Size	Upright Dimensions
AFO-KIT-A	Adult	11", 10-1/2", 10", 9-1/2", 9", 8-1/2", 8"	3/16" x 5/8"
AFO-KIT-B	Youth	9", 8-1/4", 7-1/2", 6-3/4"	3/16" x 5/8"
AFO-KIT-C	Child	6-3/4", 6", 5-1/4", 4-1/2"	3/16" x 1/2"

NOTE: Please specify desired stirrup size with each kit, e.g., AFO-KIT-A10.

MODEL MH-602-000 ULTRA G® KNEE SPIKE KIT

The Ultra G® Knee Spike Kit was developed by Wade Bader, CPO, to custom fabricate a laminated knee orthosis.

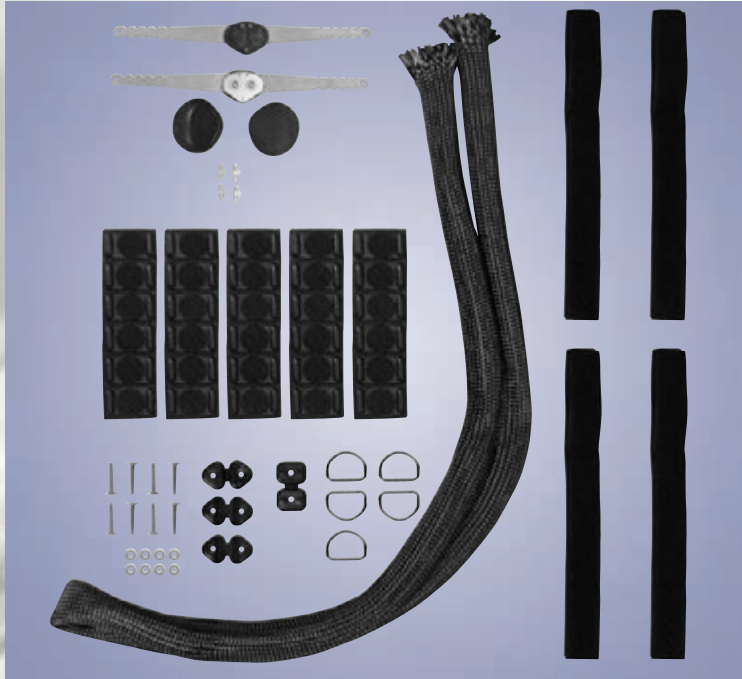

Sold Separately:

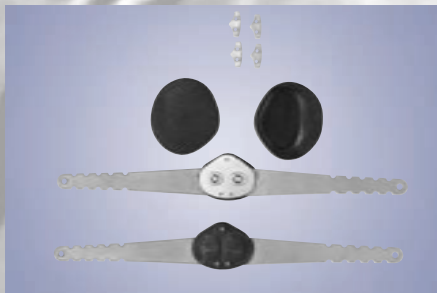

MH-601-000
Knee Spike Joints with 180°, 175°
and 170° Extension Stops



MH-601-106
Knee Spike Strapping Kit

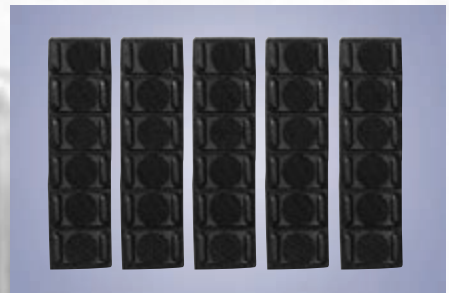

MH-601-108
Knee Spike Strap Pads

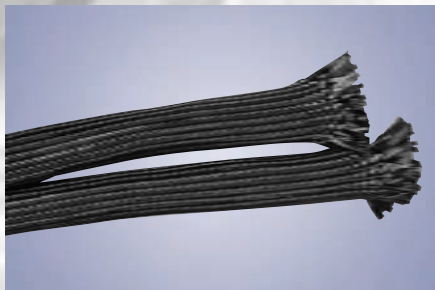

MH-601-109
Knee Spike Braid

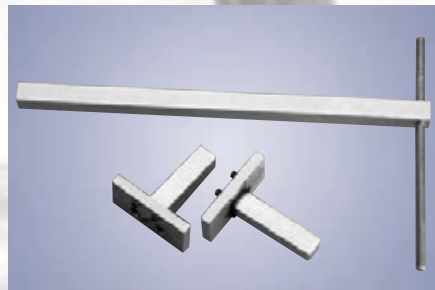

MJ-020-000
Knee Spike Alignment Kit

KNEE JOINT ACCESSORIES AND COST SAVING KITS

SCOTT-CRAIG™ PARAPLEGIA KITS

MODELS SC-1001-UK / SC-1003-UK

SCOTT-CRAIG™ UNILATERAL PARAPLEGIA KIT

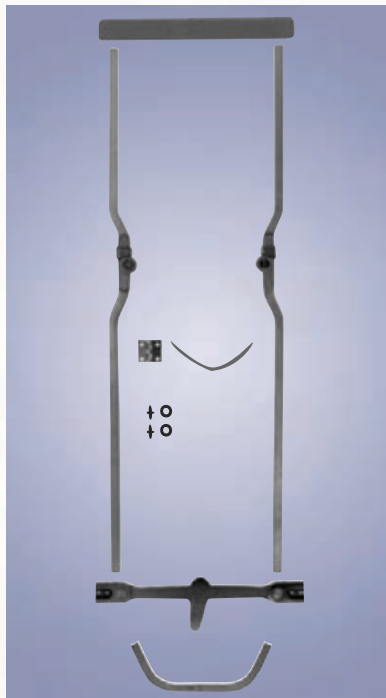

The unique Scott-Craig™ uprights offset the knee joint axis of motion posteriorly. The aluminum uprights fit into "A" size Becker joints and then taper to a 1/4" x 5/8" dimension.

INCLUDES:

- One pair of 1001 Ring Lock or 1003 Automatic Spring Lever knee joints with Scott-Craig™ uprights
- One pair of 2825 Double Action ankle joints with pins
- One 2900-A Double Action stirrup (please specify stirrup size)
- One pre-formed anterior opening calf band with hinge and fastener
- One aluminum thigh band
- One stirrup strut

Order No.	Description
SC-1001-UK	Unilateral Scott-Craig™ Kit with Ring Lock knee joints
SC-1003-UK	Unilateral Scott-Craig™ Kit with Automatic Spring Lever knee joints

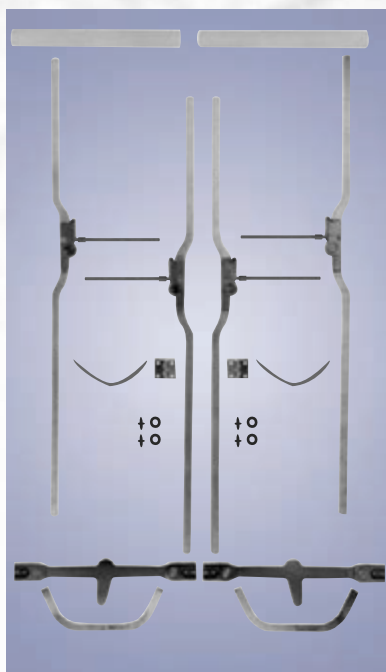

MODELS SC-1001-BK / SC-1003-BK

SCOTT-CRAIG™ BILATERAL PARAPLEGIA KIT

This kit is the same as above, except it is for use in bilateral applications.

INCLUDES:

- Two pairs of 1001 Ring Lock or 1003 Automatic Spring Lever knee joints with Scott-Craig™ uprights
- Two pairs of 2825 Double Action ankle joints with pins
- Two 2900-A Double Action stirrups (please specify stirrup size)
- Two pre-formed anterior opening calf bands with hinges and fasteners
- Two aluminum thigh bands
- Two stirrup struts

Order No.	Description
SC-1001-BK	Bilateral Scott-Craig™ Kit with Ring Lock knee joints
SC-1003-BK	Bilateral Scott-Craig™ Kit with Automatic Spring Lever knee joints

SCOTT-CRAIG™ COMPONENTS

Order No.	Description
SC-1001-A	Posterior Offset Ring Lock knee joints with Scott-Craig™ Uprights
SC-1003-A	Posterior Offset Automatic Spring Lever knee joints with Scott-Craig™ Uprights
SC-20	Anterior Opening Swing Band with Hinge
SC-30	Stirrup Strut
SC-40	Spreader Bar (available in 4", 4.5", 5", 5.5" and 6" lengths)